

Loria R32 range

The heat pump for new-build projects, designed in France



The Loria R32 is the Atlantic heat pump dedicated to the new-build.

Equipped with a plate heat exchanger, an outdoor unit that uses R32 and Inverter technology, its performance ensures comfort through both heating and sanitary hot water.

Its compact size also means it easily fits into your home. Sensorless regulation via the 'Atlantic Smart Adapt' function keeps your installation quick and simple.

TECHNICAL BENEFITS

A complete solution for new-build projects

- Operation without an outdoor sensor with Atlantic Smart Adapt
- A compact, cost-efficient solution
- Magnetic mud pot as standard
- Cooling (optional kit)

EFFICIENCY GAINS

- COP up to 5.07
- DHW COP of 3.26 (Duo version)
- ErP class up to A+++ and seasonal energy efficiency up to 192%
- Inverter regulation





EASY MAINTENANCE

- Tilting electrical box for easy access to internal components
- **Loria R32 (1 service):** filter valve (standard) outside the hydraulic module, for easy removal and cleaning
- **Loria Duo R32 (2 services):** built-in magnetic mud container filter as standard

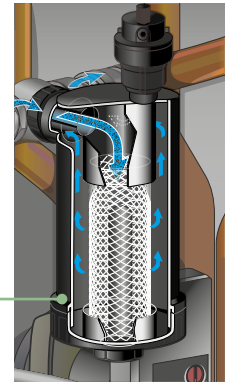

Inverter Regulation

A SIMPLE WAY TO CONFIGURE THE HEAT PUMP

- Inverter regulation acting directly on compressor speed
- Adjustable weather compensation
- Floor drying function
- Depending on the option, the system manages:
 - 2 heating zones
 - Cooling
 - Sanitary hot water equipment

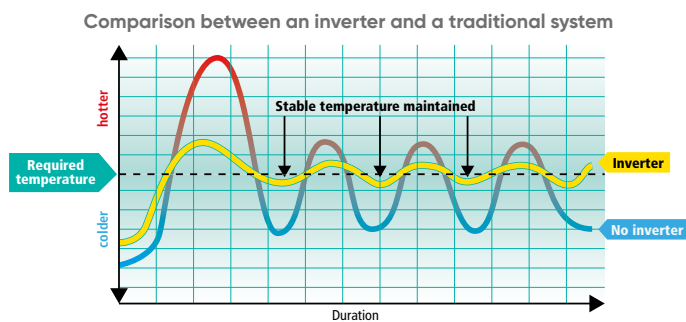

ATLANTIC NAVISTEM 100H INTERFACE FOR FAST ACCESS

- Backlit display
- Code-based navigation
- Control of the various modes (weekly programming, continuous, holiday, etc.)
- Regulation based on the outdoor temperature with Atlantic Smart Adapt (no outdoor sensor) and energy use display



Connected modulating thermostat: Navilink 128 Radio-Connect



Navilink 128 Radio-connect

Benefits of this solution

- Connected thermostat and remote comfort with the Atlantic Cozytouch app
- 2 in 1: Basic or Programmed mode
- Set-up tunnel for quick and simple installation



Loria R32

Medium temperature inverter air-to-water split heat pump – heating alone



Remote piloting



+ BENEFITS

- Easy to install and maintain thanks to the direct access given to the hydraulic design
- Compact, cost-efficient solution for all your new-build needs
- Operation without an outdoor sensor with Atlantic Smart Adapt

DESCRIPTION

- Refrigerant circuit running on R32
- 4 models: 4 to 10 kW
- Single-phase models
- Navistem 100H regulation based on outside temperature
- Integrated electric back-up heater
- Inverter regulation

AVAILABLE OPTIONS

- Magnetic mud filter
- 2 zones kit (plug-and-play kit)
- Cooling kit*
- Separate hot water tank
- Room controller

COMPATIBLE MODULATING THERMOSTAT: NAVILINK 128 RADIO-CONNECT

- Modern design
- Simplified programming through integrated assistance
- Remote control and display of consumption with the Cozytouch application via Navilink 128 Radio-Connect



Practical trainings

that will help you save time and be more efficient.



On-site trainings

- PAC 6-03-4: Heat pumps air to water – 1 day
- PAC 6-05-4: Commissioning maintenance and service – 1 day



Online trainings

- PAC 6-13-2: Heat pump installation commissioning – ½ day
- PAC 6-15-4: Heat pump services, test & breakdowns – ½ day

Up to



35°C



55°C



Cozytouch

INDOOR HYDRAULIC MODULE

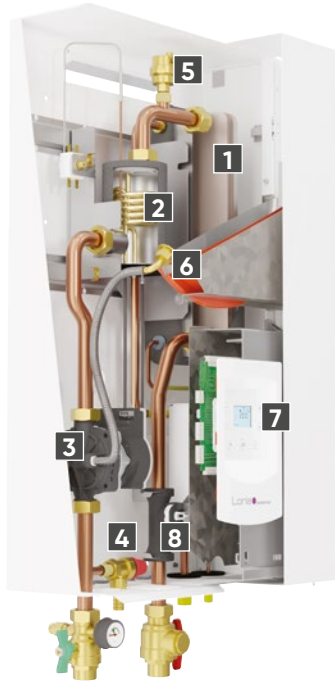

- 1 Plate heat exchanger
- 2 3 kW booster heater
- 3 Low-consumption circulating pump made of composite materials
- 4 Valve made of composite materials
- 5 Drain valve
- 6 8L expansion vessel
- 7 Navistem 100H interface
- 8 Flow controller

OUTDOOR INVERTER UNIT

- 1 Low-noise, high-output ventilator
- 2 Electric variable speed motor
- 3 "Inverter" control module
- 4 Control lights and buttons
- 5 Connection terminals (power supply and interconnection)
- 6 Refrigerant accumulator bottle
- 7 Cycle reversing valve
- 8 Anti-corrosion treated metal cover
- 9 High-performance exchange surface evaporator; anti-corrosion treated hydrophilic aluminium fins and grooved copper tubes
- 10 Electronic expansion valve
- 11 Noise and temperature insulated "Inverter" compressor
- 12 Refrigerating connection valves (flared connectors) with protective cover

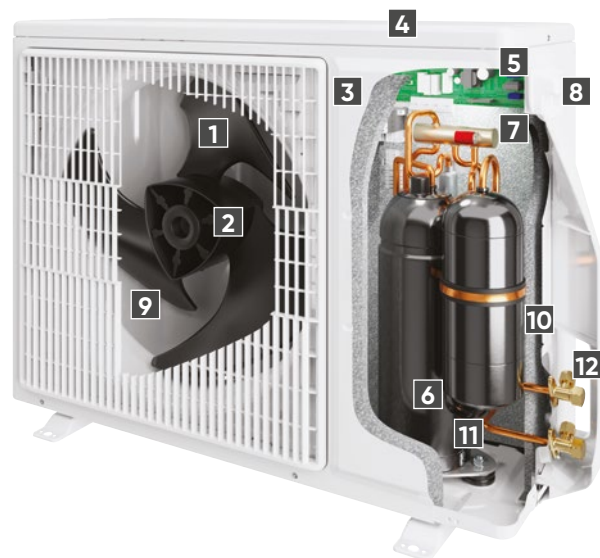

TECHNICAL CHARACTERISTICS AND PERFORMANCE

DESCRIPTION	UNIT	LORIA 6004 R32	LORIA 6006 R32	LORIA 6008 R32	LORIA 6010 R32
Refrigerant		R32	R32	R32	R32
TECHNICAL CHARACTERISTICS AND PERFORMANCE					
Energy class - heating (35°C/55°C) package	-	A+++ / A++	A+++ / A++	A+++ / A++	A+++ / A++
Thermal output (35°C / 55°C)	kW	5 / 5	6 / 5	7 / 6	9 / 9
Annual energy consumption - heating (35°C / 55°C)	kWh	2418 / 3018	2614 / 3307	2901 / 3751	3796 / 5014
Seasonal energy efficiency - heating (35° / 55°) without an outdoor sensor	%	182 / 128	192 / 134	187 / 136	188 / 141
Seasonal energy efficiency - heating (35° / 55°) with an outdoor sensor	%	184 / 130	190 / 132	185 / 134	186 / 139
Sound power (indoor / outdoor)	dB(A)	40 / 57	40 / 57	40 / 60	40 / 62
GENERAL CHARACTERISTICS					
SCOP (35°/55°)		4.61 / 3.29	4.82 / 3.37	4.70 / 3.41	4.73 / 3.54
Heating capacity +7°C/+35°C - UH	kW	4.60	5.60	7.50	9.80
COP +7°C/+35°C - UH		4.83	4.81	4.52	4.53
Heating capacity -7°C/+35°C - UH	kW	4.50	5.30	5.90	9.20
COP -7°C/+35°C - UH		2.94	2.73	2.72	2.63
Heating capacity +7°C/+55°C - Rad	kW	4.50	5.60	7.20	9.50
COP +7°C/+55°C - Rad		2.72	2.77	2.77	2.85
Heating capacity -7°C/+55°C - Rad	kW	3.90	4.25	5.30	8.00
COP -7°C/+55°C - Rad		1.91	1.95	1.96	2.01
Electrical backup heating capacity	kW	3	3	3	3
INDOOR UNIT					
Noise level ⁽¹⁾	dB(A)	32	32	32	32
Unladen weight/filled weight	kg	42 / 46	42 / 46	42 / 46	42 / 46
HYDRAULIC CHARACTERISTICS					
Vessel expansion capacity	l	8	8	8	8
Heating circuit input and output diameters (male thread)	pouce	1	1	1	1
Recommended operating range min/max - hot mode	°C	-20 / +35	-20 / +35	-20 / +35	-20 / +35
ELECTRICAL CONNECTION					
Power supply		230 V / 50 Hz	230 V / 50 Hz	230 V / 50 Hz	230 V / 50 Hz
Power consumption on standby	W	5	5	5	5
Circuit breaker rating for heat pump booster heaters curve C	A	16	16	16	16
Heat pump booster heater power cables	mm ²	3G 1.5	3G 1.5	3G 1.5	3G 1.5
FUJITSU OUTDOOR UNIT					
Noise level ⁽²⁾	dB(A)	35	35	38	40
Weight in operation	kg	39	39	42	62
REFRIGERANT CHARACTERISTICS					
Gas diameter	pouce	1/2	1/2	1/2	5/8
Liquid diameter	pouce	1/4	1/4	1/4	3/8
Refrigerant factory load HFC R32	g	970	970	1020	1630
Quantity of fluid in tonnes of CO ₂ -eq	t	1	1	1	1
Min/max length	m	3 / 30	3 / 30	3 / 30	3 / 30
Max difference in height	m	20	20	20	20
Max length with no additional load	m	15	15	15	20
Masse de gaz à rajouter par m supplémentaire	g	25	25	25	20
RACCORDEMENTS ÉLECTRIQUES					
Alimentation		230 V / 50 Hz	230 V / 50 Hz	230 V / 50 Hz	230 V / 50 Hz
Standby power	W	38	38	38	38
Max intensity (excluding booster heaters)	A	13	13	18	19
Circuit breaker rating C curve	A	16	16	20	32
Power cable, outdoor module	mm ²	3G1.5	3G1.5	3G2.5	3G 4 or 6
Cables connecting the outdoor and indoor modules	mm ²	4G1.5	4G1.5	4G1.5	4G1.5

(1) Acoustic pressure at 1m from HP, 1,5 m from the ground, open field, directivity 2.
 (2) Acoustic pressure at 5m from HP, 1,5 m from the ground, open field, directivity 2.

INSTALLATION DIMENSIONS (mm)

Outdoor Inverter unit
Loria R32 5 and 6

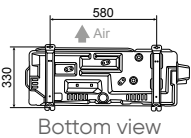

Bottom view

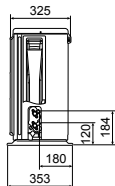

Side view

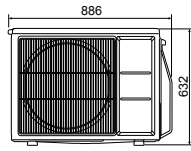

Front view

Outdoor Inverter unit
Loria R32 8

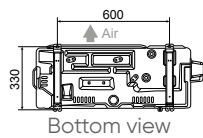

Bottom view

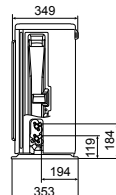

Side view

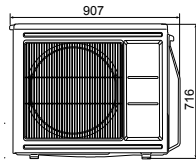

Front view

Outdoor Inverter unit
Loria R32 10

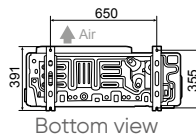

Bottom view

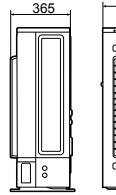

Side view

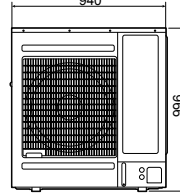

Front view

Indoor hydraulic module

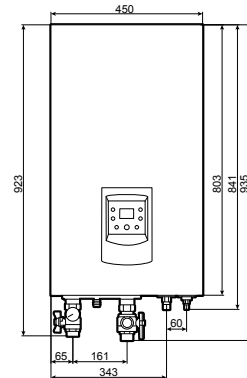

Front view

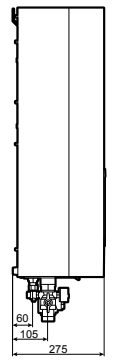

Side view

INSTALLATION SCHEMATICS

A - 1 HEATING CIRCUIT

- 1 Outdoor unit and floor supports⁽¹⁾
- 2 Refrigeration links⁽¹⁾
- 3 Indoor unit
- 4 Modulating thermostat⁽¹⁾
- 5 Magnetic sludge filter⁽¹⁾
- 6 Buffer tank⁽²⁾
- 7 DHW boiler

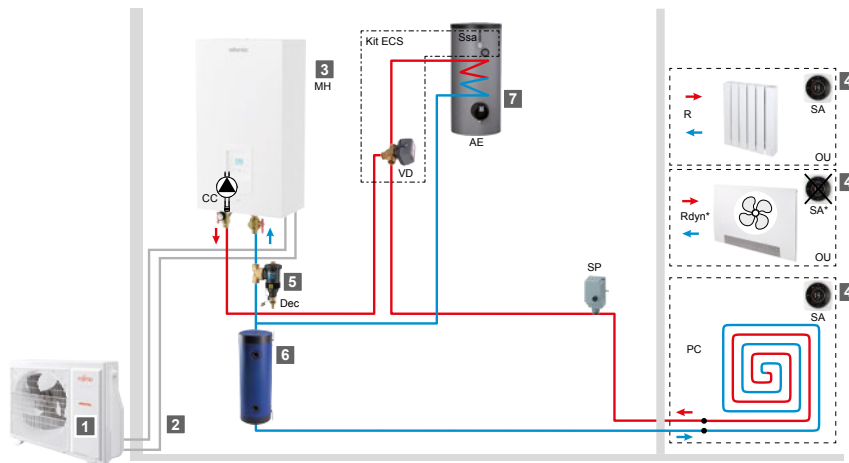

(1) Optional

(2) Depending on the emitter type and quantity of water in the heating circuit, it may be necessary to install a buffer tank.

B - 2 HEATING CIRCUITS

- 1 Outdoor unit and floor supports⁽¹⁾
- 2 Refrigeration links⁽¹⁾
- 3 Indoor unit
- 4 Modulating thermostat⁽¹⁾
- 5 Magnetic sludge filter⁽¹⁾
- 6 Buffer tank⁽²⁾
- 7 2-circuit kit⁽¹⁾

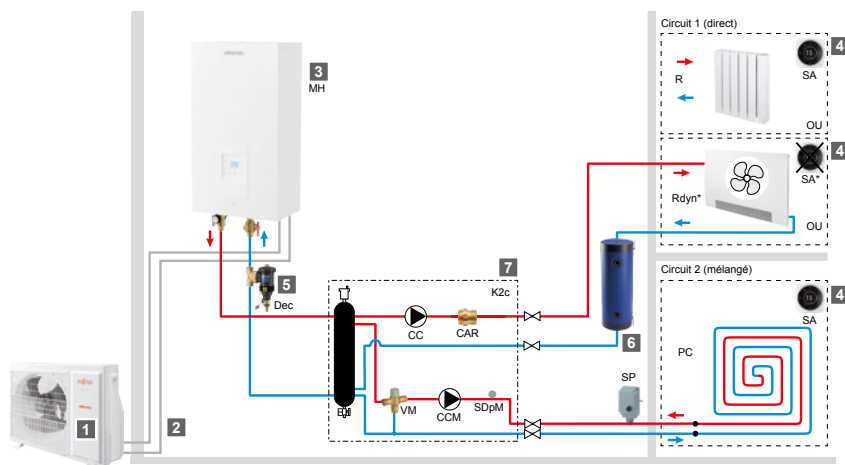

(1) Optional

(2) Depending on the emitter type and quantity of water in the heating circuit, it may be necessary to install a buffer tank.

Detailed hydraulic and electrical diagrams included in installation manual.

Loria Duo R32

Medium temperature inverter air-to-water split heat pump – integrated DHW



Remote piloting



+ BENEFITS

- Easy to install and maintain thanks to the direct access given to the hydraulic design
- Operation without an outdoor sensor with Atlantic Smart Adapt
- Compact, cost-efficient solution for all your new-build needs
- DHW tank (190 L) with high-performance regulation

DESCRIPTION

- Refrigerant circuit running on R32
- 5 models: 3 to 10 kW
- Single-phase models
- Heating and DHW integrated
- Navistem 100H regulation based on outside temperature
- Inverter regulation

AVAILABLE OPTIONS

- 2 zones kit (plug-and-play kit)
- Cooling kit
- Room controller

COMPATIBLE MODULATING THERMOSTAT: NAVILINK 128 RADIO-CONNECT

- Modern design
- Simplified programming through integrated assistance
- Remote control and display of consumption with the Cozytouch application via Navilink 128 Radio-Connect



Practical trainings

that will help you save time and be more efficient.



On-site trainings

- PAC 6-03-4: Heat pumps air to water – 1 day
- PAC 6-05-4: Commissioning maintenance and service – 1 day



Online trainings

- PAC 6-13-2: Heat pump installation commissioning – ½ day
- PAC 6-15-4: Heat pump services, test & breakdowns – ½ day

Up to



35°C



55°C



Cozytouch

INDOOR HYDRAULIC MODULE



- 1 Removable sludge filter as standard
- 2 Hydrobloc
- 3 190L tank made of enamelled steel
- 4 Expansion vessel 8L
- 5 Navistem 100H interface
- 6 Plate heat exchanger
- 7 3 kW booster heater
- 8 Flow controller
- 9 Booster heater and magnesium anode

OUTDOOR INVERTER UNIT

- 1 Low-noise, high-output ventilator
- 2 Electric variable speed motor
- 3 "Inverter" control module
- 4 Control lights and buttons
- 5 Connection terminals (power supply and interconnection)
- 6 Refrigerant accumulator bottle
- 7 Cycle reversing valve
- 8 Anti-corrosion treated metal cover
- 9 High-performance exchange surface evaporator; anti-corrosion treated hydrophilic aluminium fins and grooved copper tubes
- 10 Electronic expansion valve
- 11 Noise and temperature insulated "Inverter" compressor
- 12 Refrigerating connection valves (flared connectors) with protective cover

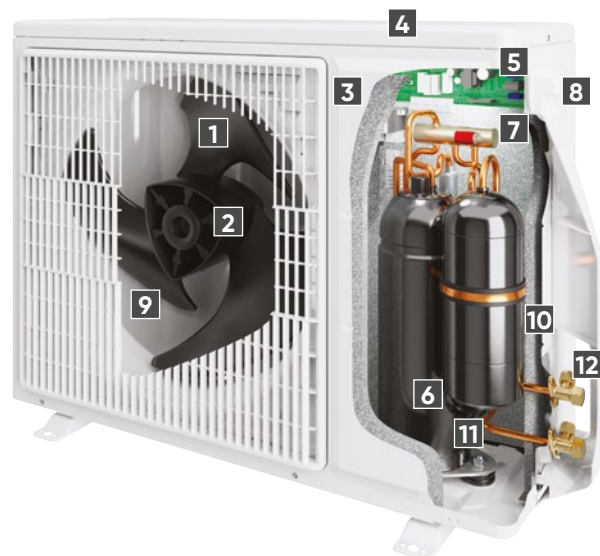

TECHNICAL CHARACTERISTICS AND PERFORMANCE

DESCRIPTION	UNIT	LORIA DUO 6003 R32	LORIA DUO 6004 R32	LORIA DUO 6006 R32	LORIA DUO 6008 R32	LORIA DUO 6010 R32
Refrigerant		R32	R32	R32	R32	R32
CHARACTERISTICS AND HEATING PERFORMANCE						
Energy class - heating (35°C/55°C) package	-	A+++ / A++	A+++ / A++	A+++ / A++	A+++ / A++	A+++ / A++
Thermal output (35°C / 55°C)	kW	4 / 4	5 / 5	6 / 5	7 / 6	9 / 9
Annual energy consumption - heating (35°C / 55°C)	kWh	930 / 1313	2418 / 3018	2614 / 3307	2901 / 3751	3796 / 5014
Seasonal energy efficiency - heating (35° / 55°) without an outdoor sensor	%	181 / 126	182 / 128	190 / 132	185 / 134	186 / 139
Seasonal energy efficiency - heating (35° / 55°) with an outdoor sensor	%	183 / 128	184 / 130	192 / 134	187 / 136	188 / 141
Sound power (indoor/outdoor)	dB(A)	40 / 57	40 / 57	40 / 57	40 / 60	40 / 62
DHW CHARACTERISTICS AND PERFORMANCE						
Draw-off profile - DHW	-	L	L	L	L	L
Energy class - DHW	-	A+	A+	A+	A+	A+
Annual energy consumption in kWh - DHW	kWh	777	777	777	777	777
Seasonal energy efficiency - DHW	%	132	132	132	132	132
GENERAL CHARACTERISTICS						
SCOP (35°/55°)		4.60 / 3.22	4.61 / 3.29	4.82 / 3.37	4.7 / 3.41	4.73 / 3.54
Heating capacity +7°C/+35°C - UH	kW	3.30	4.60	5.60	7.50	9.80
COP +7°C/+35°C - PC		2.20	4.83	4.81	4.52	4.53
Heating capacity -7°C/+35°C - UH	kW	3.50	4.50	5.30	5.90	9.20
COP -7°C/+35°C - PC		3.03	2.94	2.73	2.72	2.63
Heating capacity +7°C/+55°C - Rad	kW	3.10	4.50	5.60	7.20	9.50
COP +7°C/+55°C - Rad		2.55	2.72	2.77	2.77	2.85
Heating capacity -7°C/+55°C - Rad	kW	3.30	3.90	4.25	5.30	8.00
COP -7°C/+55°C - Rad		1.77	1.91	1.95	1.96	2.01
Electrical backup heater heating capacity	kW	3	3	3	3	3
INDOOR UNIT						
Noise level ⁽¹⁾	dB(A)	32	32	32	32	32
Unladen weight/filled weight	kg	135 / 330	135 / 330	135 / 330	135 / 330	135 / 330
HYDRAULIC CHARACTERISTICS						
Vessel expansion capacity	l	8	8	8	8	8
DHW tank capacity	l	190	190	190	190	190
DHW electrical backup heating capacity	kW	1.60	1.60	1.60	1.60	1.60
Materials DHW tank		Enamelled steel				
Warming-up time in compliance with EN16147	h/mn	1h36	1h36	1h36	1h36	1h36
Reference temperature in compliance with EN16147	°C	52.5	52.5	52.5	52.5	52.5
DHW COP in compliance with EN16147	-	3.26	3.26	3.26	3.26	3.26
Max usable volume of hot water in compliance with EN16147	L	243	243	243	243	243
Reserve power in compliance with EN16147	W	31	31	31	31	31
Heating circuit input and output diameters (male thread)	pouce	1	1	1	1	1
Recommended operating range min/max - hot mode	°C	-20 / +35	-20 / +35	-20 / +35	-20 / +35	-20 / +35
ELECTRICAL CONNECTION						
Power supply		230 V / 50 Hz	230 V / 50 Hz	230 V / 50 Hz	230 V / 50 Hz	230 V / 50 Hz
Power consumption on standby	W	5	5	5	5	5
Circuit breaker rating for heat pump booster heaters curve C	A	16	16	16	16	16
Heat pump booster heater power cables	mm ²	3G 1.5	3G 1.5	3G 1.5	3G 1.5	3G 1.5
FUJITSU OUTDOOR UNIT						
Noise level ⁽²⁾	dB(A)	35	35	35	38	40
Weight in operation	kg	39	39	39	42	62
REFRIGERANT CHARACTERISTICS						
Gas diameter	pouce	1 / 2	1 / 2	1 / 2	1 / 2	5 / 8
Liquid diameter	pouce	1 / 4	1 / 4	1 / 4	1 / 4	3 / 8
Refrigerant factory load HFC R32	g	970	970	970	1020	1630
Quantity of fluid in tonnes of CO ₂ -eq	t	1	1	1	1	1
Min/max length	m	3 / 30	3 / 30	3 / 30	3 / 30	3 / 30
Max difference in height	m	20	20	20	20	20
Max length <1> with no additional load	m	15	15	15	15	20
Quantity of gas to be added per additional m	g	25	25	25	25	20
ELECTRICAL CONNECTIONS						
Power supply		230 V / 50 Hz	230 V / 50 Hz	230 V / 50 Hz	230 V / 50 Hz	230 V / 50 Hz
Standby consumption (Average power consumed by pump)	W	38	38	38	38	38
Max intensity (excluding booster heaters)	A	13	13	13	18	19
Circuit breaker rating C curve	A	16	16	16	20	32
Power cable, outdoor module	mm ²	3G1.5	3G1.5	3G1.5	3G2.5	3G 4 or 6
Cables connecting the outdoor and indoor modules	mm ²	4G1.5	4G1.5	4G1.5	4G1.5	4G1.5

(1) Acoustic pressure at 5m from HP, 5 m from the ground, open field, directivity 2.
 (2) Acoustic pressure at 5m from HP, 1,5 m from the ground, open field, directivity 2.

INSTALLATION DIMENSIONS (mm)

Outdoor Inverter unit
Loria Duo R32 3, 4 and 6

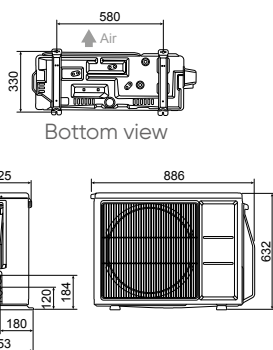

Outdoor Inverter unit
Loria Duo R32 8

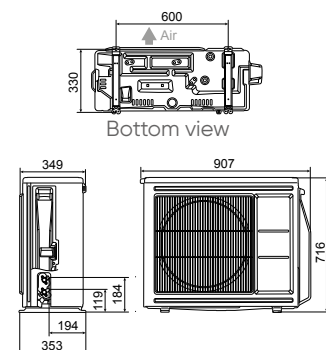

Outdoor Inverter unit
Loria Duo R32 10

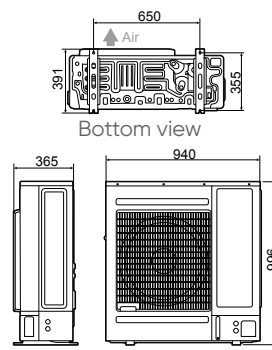

Indoor hydraulic module

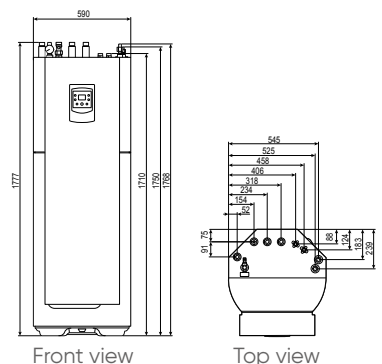

INSTALLATION SCHEMATICS

A - 1 CIRCUIT (UNDERFLOOR HEATING OR RADIATORS) + INTEGRATED DHW

- 1 Outdoor unit and floor supports⁽¹⁾
- 2 Refrigeration links⁽¹⁾
- 3 Indoor unit
- 4 Modulating thermostat (except with dynamic radiator)⁽¹⁾
- 5 Buffer tank⁽²⁾

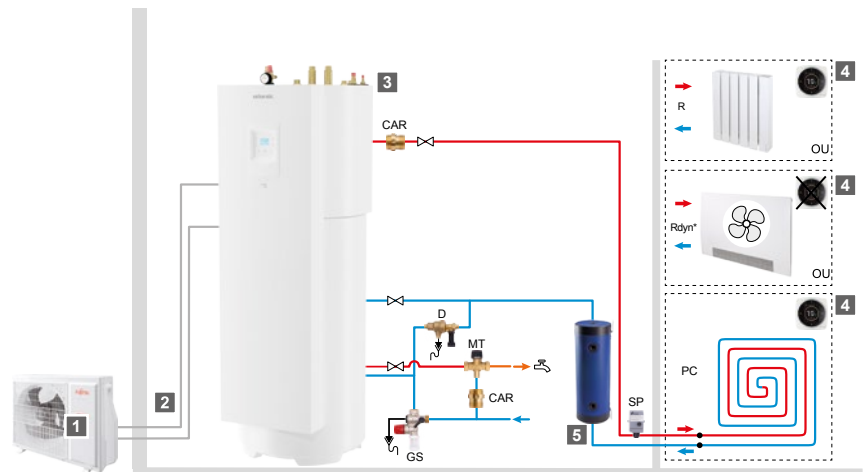

(1) Optional

(2) Depending on the emitter type and quantity of water in the heating circuit, it may be necessary to install a buffer tank.

B - 2 CIRCUITS (UNDERFLOOR HEATING OR RADIATORS) + INTEGRATED DHW

- 1 Outdoor unit and floor supports⁽¹⁾
- 2 Refrigeration links⁽¹⁾
- 3 Indoor unit
- 4 Modulating thermostat (except with dynamic radiator)⁽¹⁾
- 5 Buffer tank⁽²⁾
- 6 2nd circuit

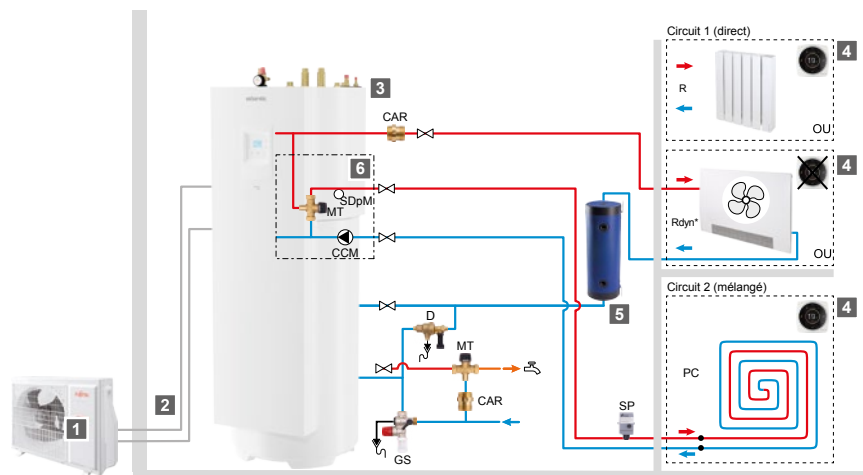

(1) Optional

(2) Depending on the emitter type and quantity of water in the heating circuit, it may be necessary to install a buffer tank.

Detailed hydraulic and electrical diagrams included in installation manual.

Loria R32 range accessories

MODULATING ROOM CONTROLLER NAVILINK 105 OR NAVILINK 128 RADIO-CONNECT



+ PRODUCT

- Simplified programming through integrated assistance
- DHW control
- Quick access to all useful information: energy consumption, active mode, ambient and outdoor temperature
- Made in France
- Remote controle via Cozytouch App for Navilink 128 Radio-Connect

DESCRIPTION

- Wired model
- Full thermal comfort control
- Heating or cooling mode activation

MAGNETIC MUD FILTER (FOR LORIA R32)



+ PRODUCT

- Capture impurities in the heating circuit

DESCRIPTION

- Magnetic mud filter with a screen filter, decanting effect and magnetic effect
- Integrated in Loria Duo

DOMESTIC HOT WATER TANK MILEO / MILEO+



+ PRODUCT

- DHW kit allowing quick connection between DHW tank and heat pump
- 2 ranges:
 - High-performance coil for air-to-water and ground source heat pumps (Mileo)
 - Extra-high performance coil for air-to-water and ground source heat pumps (Mileo+)

DESCRIPTION

- DHW storage tank range
- 160 to 500L tanks
- Glass-lined steel tank
- Electric back-up heater 3.3 kW supplied as standard
- Thermometer

MODEM HARNESS KIT



+ PRODUCT

- Remote piloting of your heat pump operating modes

DESCRIPTION

- Modem harness allowing to switch heat pump operating mode remotely

2 ZONES KIT



2 zones kit for single service heat pump

+ PRODUCT

- Integrated low consumption circulation pump
- Compatible with underfloor heating/cooling, radiators, fan coils

DESCRIPTION

- 2 zones kit to control two hydraulic zones independently

COOLING KIT



+ PRODUCT

- Kit integrates into hydraulic module
- Simple and quick installation
- Year-round comfort

DESCRIPTION

- Plug-in cooling kit
- Allows reversibility function (for Loria & Loria Duo)

ASSEMBLY SUPPORT



+ PRODUCT

- Hides the lower part of the hydraulic module installation
- Makes hydraulic module installation more user-friendly and aesthetic

DESCRIPTION

- Allowing to derive a heat pump pipes upwards behind hydraulic module

ACCESSORIES FOR OUTDOOR UNIT



White PVC floor support (x2)



Black rubber floor support (x2)



Wall bracket* 600 mm (with bar)



Heating cable



Refrigerant pipes**



Protection pipes for refrigerant pipes

*Installer has to make sure that the wall bracket installation will not transmit vibration (ground position is being preferred)

**For a better protection of insulation against UV, Atlantic recommends the installation of protection pipes together with refrigerant pipes