

## 2. General Troubleshooting

### 2.1 Error Display (Indoor Unit)

When the indoor unit encounters a recognized error, the operation lamp will flash in a corresponding series, the timer lamp may turn on or begin flashing, and an error code will be displayed. These error codes are described in the following tables:

Operation Lamp	Timer Lamp	Display	Error Information	Solution
1 time	OFF	E0	Indoor unit EEPROM parameter error	TS19
2 times	OFF	E1	Indoor / outdoor unit communication error	TS20
3 times	OFF	E2	Zero-crossing signal detection error(for some models)	TS22
4 times	OFF	E3	The indoor fan speed is operating outside of the normal range	TS23
5 times	OFF	E4	Indoor room temperature sensor T1 is in open circuit or has short circuited	TS26
6 times	OFF	E5	Evaporator coil temperature sensor T2 is in open circuit or has short circuited	TS26
9 times	OFF	E7/EH0b	Indoor PCB / Display board communication error(for some models)	TS27
7 times	OFF	E8	Refrigerant leak detected	TS28
1 times	ON	F0	Current overload protection	TS29
2 times	ON	F1	Outdoor room temperature sensor T4 is in open circuit or has short circuited	TS26
3 times	ON	F2	Condenser coil temperature sensor T3 is in open circuit or has short circuited	TS26
4 times	ON	F3	Compressor discharge temperature sensor TP is in open circuit or has short circuited	TS26
7 times	ON	F6	Evaporator coil outlet temperature sensor T2B is in open circuit or has short circuited(for free-match indoor units)	TS26
5 times	ON	F4	Outdoor unit EEPROM parameter error	TS19
6 times	ON	F5	The outdoor fan speed is operating outside of the normal range(for some models)	TS23
1 times	FLASH	P0	IPM malfunction or IGBT over-strong current protection	TS30
2 times	FLASH	P1	Over voltage or over low voltage protection	TS31
3 times	FLASH	P2	High temperature protection of IPM module or High pressure protection	TS32
5 times	FLASH	P4	Inverter compressor drive error	TS34
7 times	FLASH	P6	Low pressure protection(for some models)	TS35
6 times	FLASH	P5/--	Indoor units mode conflict(match with multi outdoor unit)	--

#### For other errors:

The display board may show a garbled code or a code undefined by the service manual. Ensure that this code is not a temperature reading.

#### Troubleshooting:

Test the unit using the remote control. If the unit does not respond to the remote, the indoor PCB requires replacement. If the unit responds, the display board requires replacement.

**For some models**

Operation Lamp	Timer Lamp	LED Display	Error Information	Solution
1 time	OFF	<b>E400</b>	Indoor unit EEPROM parameter error	TS19
2 times	OFF	<b>E401</b>	Indoor / outdoor unit communication error	TS20
3 times	OFF	<b>E402</b>	Zero-crossing signal detection error(for some models)	TS22
4 times	OFF	<b>E403</b>	The indoor fan speed is operating outside of the normal range	TS23
5 times	OFF	<b>E451</b>	Outdoor unit EEPROM parameter error(for some models)	TS19
5 times	OFF	<b>E452</b>	Condenser coil temperature sensor T3 is in open circuit or has short circuited	TS26
5 times	OFF	<b>E453</b>	Outdoor room temperature sensor T4 is in open circuit or has short circuited	TS26
5 times	OFF	<b>E454</b>	Compressor discharge temperature sensor TP is in open circuit or has short circuited	TS26
5 times	OFF	<b>E456</b>	Evaporator coil outlet temperature sensor T2B is in open circuit or has short circuited(for free-match indoor units)	TS26
6 times	OFF	<b>E460</b>	Indoor room temperature sensor T1 is in open circuit or has short circuited	TS26
6 times	OFF	<b>E461</b>	Evaporator coil temperature sensor T2 is in open circuit or has short circuited	TS26
12 times	OFF	<b>E407</b>	The outdoor fan speed is operating outside of the normal range(for some models)	TS23
9 times	OFF	<b>E40b</b>	Indoor PCB / Display board communication error(for some models)	TS27
8 times	OFF	<b>E40c</b>	Refrigerant leak detected	TS28
7 times	FLASH	<b>P400</b>	IPM malfunction or IGBT over-strong current protection	TS30
2 times	FLASH	<b>P401</b>	Over voltage or over low voltage protection	TS31
3 times	FLASH	<b>P402</b>	High temperature protection of IPM module or High pressure protection	TS32
5 times	FLASH	<b>P404</b>	Inverter compressor drive error	TS34
1 time	FLASH	<b>P408</b>	Current overload protection(for some models)	TS29
7 times	FLASH	<b>P403</b>	Low pressure protection(for some models)	TS35
1 times	ON	--	Indoor units mode conflict(match with multi outdoor unit)	--

### LED flash frequency:

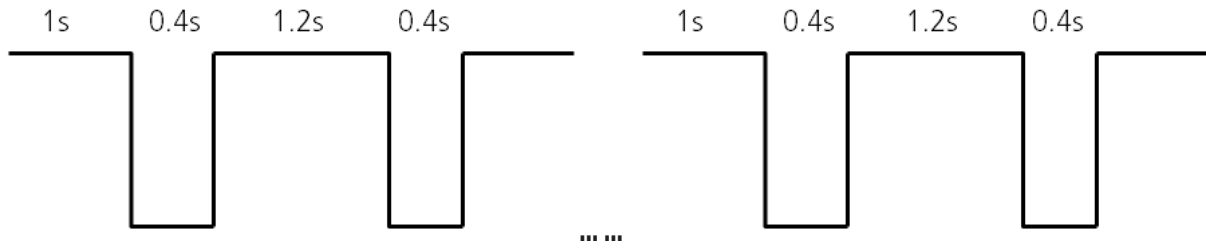

## 2.2 Error Display (For Some Outdoor Units)

There are 2 LED lights (RED color and GREEN color) welded in outdoor main board. After power on, LED show different actions when encounter different problems.

No.	Problem	LED(GREEN)	LED(RED)	Solution
1	Standby normally	ON	OFF	-
2	Operate normally	OFF	ON	-
3	Compressor driven chip EEPROM parameter error	ON	FLASH	TS19
4	IPM malfunction or IGBT over-strong current protection	FLASH	OFF	TS30
5	Over voltage or too low voltage protection	ON	ON	TS31
6	Inverter compressor drive error	OFF	FLASH	TS34
7	Inverter compressor drive error	FLASH	LIGHT	TS34
8	Communication error between outdoor main chip and compressor driven chip	FLASH	FLASH	TS19

### 3. Complain Record Form

#### Complain Record Form

Request No.:

Date:

Installation Date:

Service Date:

Customer Information			
Name		Telephone No.	
Home Address			
Email			
Product Information			
Indoor Unit Model		Outdoor Unit Model	
Serial No. of indoor unit			
Serial No. of outdoor unit			
Working Mode	<input type="checkbox"/> Cooling <input type="checkbox"/> Heating <input type="checkbox"/> Fan only <input type="checkbox"/> Dry		
Setting temperature	_____°C / °F	Fan speed	<input type="checkbox"/> Turbo <input type="checkbox"/> High <input type="checkbox"/> Medium <input type="checkbox"/> Low <input type="checkbox"/> Auto
Temperature of air inlet	_____°C / °F	Temperature of air outlet	_____°C / °F
Installation / Condition Information			
Indoor temperature	_____°C / °F	Indoor humidity	_____ %RH
Outdoor temperature	_____°C / °F	Outdoor humidity	_____ %RH
Length of Connecting pipe		Pipe diameter	Gas pipe:          Liquid pipe:
Length of Wiring		wire diameter	
System Running Pressure	_____MPa   or   _____Bar   or   _____PSI		
Room size (L*W*H)			
Photo of Installation of Indoor unit (Photo #1)		Photo of Installation of Outdoor unit (Photo #2)	
Failure Description			
Error Code of Indoor unit		Code of Outdoor PCB	
Unit does not start			
Remote control does not work			
Indoor display shows nothing			
No cooling or heating at all			
Less cooling or heating			
Unit starts but stops shortly			
High noise			
High vibration			

Parameter Checking information by Remote controller			
Displaying code	Displaying code meaning	Display value	Display value meaning
T1	Room temperature		
T2	Indoor coil temperature		
T3	Outdoor coil temperature		
T4	Ambient temperature		
Tb	Outlet temperature of indoor coil		
TP	Discharge temperature		
TH	Suction temperature		
FT	Targeted Frequency		
Fr	Actual Frequency		
IF	Indoor fan speed		
OF	Outdoor fan speed		
LA	EXV opening steps		
CT	Compressor continuous running time		
ST	Causes of compressor stop.		
A0, A1, b0, b1, b2, b3, b4, b5, b6, dL, Ac, Uo, Td, dA, dS, dT	Reserved		

Approval from Manufacturer	
<input type="checkbox"/> Approved	
<input type="checkbox"/> More Proof needed	
<input type="checkbox"/> Rejected	

---

## 4. Information Inquiry

- To enter information inquiry status, complete the following procedure within ten seconds:
  - Press LED(or DO NOT DISTURB) 3 times.
  - Press SWING(or AIR DIRECTION) 3 times.
- Finish 1 and 2 within 10 seconds, you will hear beeps for two seconds, which means the unit goes into parameter checking mode.
- Use the LED(or DO NOT DISTURB) and SWING(or AIR DIRECTION) buttons to cycle through information displayed.
- Pressing LED(or DO NOT DISTURB) will display the next code in the sequence. Pressing SWING(or AIR DIRECTION) will show the previous.
- The following table shows information codes. The screen will display this code for two seconds, then the information for 25 seconds.

Displayed code	Explanation	Displayed value	Meaning	Additional Notes
T1	Room temperature	-1F,-1E,-1d,-1c,-1b,-1A -19—99 A0,A1,...A9 b0,b1,...b9 c0,c1,...c9 d0,d1,...d9 E0,E1,...E9 F0,F1,...F9	-25,-24,-23,-22,-21,-20 -19—99 100,101,...109 110,111,...119 120,121,...129 130,131,...139 140,141,...149 150,151,...159	<ol style="list-style-type: none"> <li>All displayed temperatures use actual values.</li> <li>All temperatures are displayed in °C regardless of remote used.</li> <li>T1, T2, T3, T4, and T2B display ranges from -25 to 70 °C. TP display ranges from -20 to 130 °C.</li> <li>The frequency display ranges from 0 to 159HZ.</li> <li>If the actual values exceed or fall short of the defined range, the values closest to the maximum and minimum values will be displayed.</li> </ol>
T2	Indoor coil temperature			
T3	Outdoor coil temperature			
T4	Ambient temperature			
TB	Outlet temperature of indoor coil			
TP	Discharge temperature			
TH	Suction temperature			
FT	Targeted frequency			
FR	Actual frequency			
IF	Indoor fan speed	0 1,2,3,4	OFF Low speed, Medium speed, High speed, Turbo.	N/A Used for some large capacity motors.
OF	Outdoor fan speed	14-FF	Actual fan speed is equal to the display value converted to decimal value and multiplied by 10. This is measured in RPM.	Used for some small capacity motors. The display value is 14-FF (hexadecimal). The corresponding fan speed ranges from 200 to 2550RPM.
LR	EXV opening angle	0-FF	Actual EXV opening value is equal to the display value converted to decimal value and then multiplied by 2.	-
CT	Compressor continuous running time	0-FF	0-255 minutes	If the actual value exceeds or falls short of the defined range, the value closest to the maximum and minimum will be displayed.
ST	Causes of compressor stop	0-99	For a detailed explanation, contact technical support.	-

Displayed code	Explanation	Displayed value	Meaning	Additional Notes
R0	Reserved	0-FF 2-28 5-20 5-25	-	-
R1				
b0				
b1				
b2				
b3				
b4				
b5				
b6				
dL				
Rc				
Uo				
Td				
dR				
dS				
dT				



---

## 5. Error Diagnosis and Troubleshooting Without Error Code

### WARNING

Be sure to turn off unit before any maintenance to prevent damage or injury.

#### 5.1 Remote maintenance

**SUGGESTION:** When troubles occur, please check the following points with customers before field maintenance.

No.	Problem	Solution
1	Unit will not start	TS14 - TS15
2	The power switch is on but fans will not start	TS14 - TS15
3	The temperature on the display board cannot be set	TS14 - TS15
4	Unit is on but the wind is not cold(hot)	TS14 - TS15
5	Unit runs, but shortly stops	TS14 - TS15
6	The unit starts up and stops frequently	TS14 - TS15
7	Unit runs continuously but insufficient cooling(heating)	TS14 - TS15
8	Cool can not change to heat	TS14 - TS15
9	Unit is noisy	TS14 - TS15

---

## 5.2 Field maintenance

	Problem	Solution
1	Unit will not start	TS16 - TS17
2	Compressor will not start but fans run	TS16 - TS17
3	Compressor and condenser (outdoor) fan will not start	TS16 - TS17
4	Evaporator (indoor) fan will not start	TS16 - TS17
5	Condenser (Outdoor) fan will not start	TS16 - TS17
6	Unit runs, but shortly stops	TS16 - TS17
7	Compressor short-cycles due to overload	TS16 - TS17
8	High discharge pressure	TS16 - TS17
9	Low discharge pressure	TS16 - TS17
10	High suction pressure	TS16 - TS17
11	Low suction pressure	TS16 - TS17
12	Unit runs continuously but insufficient cooling	TS16 - TS17
13	Too cool	TS16 - TS17
14	Compressor is noisy	TS16 - TS17
15	Horizontal louver can not revolve	TS16 - TS17

1.Remote Maintenance	Electrical Circuit				Refrigerant Circuit													
Possible causes of trouble	Power failure																	
	The main power tripped																	
	Loose connections																	
	Faulty transformer																	
	The voltage is too high or too low																	
	The remote control is powered off																	
	Broken remote control																	
	Dirty air filter																	
	Dirty condenser fins																	
	The setting temperature is higher/lower than the room's(cooling/heating)																	
	The ambient temperature is too high/low when the mode is cooling/heating																	
	Fan mode																	
	SILENCE function is activated(optional function)																	
Frosting and defrosting frequently																		
Unit will not start	☆	☆	☆	☆														
The power switch is on but fans will not start			☆	☆	☆													
The temperature on the display board cannot be set						☆	☆											
Unit is on but the wind is not cold(hot)										☆	☆	☆						
Unit runs, but shortly stops					☆					☆	☆							
The unit starts up and stops frequently					☆						☆					☆		
Unit runs continuously but insufficient cooling/heating)								☆	☆	☆	☆			☆				
Cool can not change to heat																		
Unit is noisy																		
Test method / remedy	Test voltage																	
	Close the power switch																	
	Inspect connections - tighten																	
	Change the transformer																	
	Test voltage																	
	Replace the battery of the remote control																	
	Replace the remote control																	
	Clean or replace																	
	Clean																	
	Adjust the setting temperature																	
	Turn the AC later																	
	Adjust to cool mode																	
	Turn off SILENCE function.																	
Turn the AC later																		

1.Remote Maintenance	Others					
Possible causes of trouble	Heavy load condition	Loosen hold down bolts and / or screws	Bad airproof	The air inlet or outlet of either unit is blocked	Interference from cell phone towers and remote boosters	Shipping plates remain attached
Unit will not start						
The power switch is on but fans will not start					☆	
The temperature on the display board cannot be set						
Unit is on but the wind is not cold(hot)						
Unit runs, but shortly stops						
The unit starts up and stops frequently				☆		
Unit runs continuously but insufficient cooling(heating)	☆		☆	☆		
Cool can not change to heat						
Unit is noisy		☆				☆
Test method / remedy	Check heat load	Tighten bolts or screws	Close all the windows and doors	Remove the obstacles	Reconnect the power or press <b>ON/OFF</b> button on remote control to restart operation	Remove them

2.Field Maintenance	Refrigerant Circuit														Others								
Possible causes of trouble	Compressor stuck	Shortage of refrigerant	Restricted liquid line	Dirty air filter	Dirty evaporator coil	Insufficient air through evaporator coil	Overcharge of refrigerant	Dirty or partially blocked condenser	Air or incompressible gas in refrigerant cycle	Short cycling of condensing air	High temperature condensing medium	Insufficient condensing medium	Broken compressor internal parts	Inefficient compressor	Expansion valve obstructed	Expansion valve or capillary tube closed completely	Leaking power element on expansion valve	Poor installation of feeler bulb	Heavy load condition	Loosen hold down bolts and / or screws	Shipping plates remain attached	Poor choices of capacity	Contact of piping with other piping or external plate
Unit will not start																							
Compressor will not start but fans run	☆																						
Compressor and condenser (outdoor) fan will not start																							
Evaporator (indoor) fan will not start																							
Condenser (Outdoor) fan will not start																							
Unit runs, but shortly stops		☆	☆				☆	☆								☆	☆						
Compressor short-cycles due to overload		☆					☆	☆															
High discharge pressure							☆	☆	☆	☆	☆												
Low discharge pressure		☆												☆									
High suction pressure							☆							☆				☆	☆				
Low suction pressure		☆	☆	☆	☆	☆								☆	☆	☆							
Unit runs continuously but insufficient cooling		☆	☆	☆	☆	☆		☆	☆	☆				☆					☆			☆	
Too cool																							
Compressor is noisy							☆						☆							☆	☆		☆
Horizontal louver can not revolve																							
Test method / remedy	Replace the compressor	Leak test	Replace restricted part	Clean or replace	Clean coil	Check fan	Change charged refrigerant volume	Clean condenser or remove obstacle	Purge, evacuate and recharge	Remove obstruction to air flow	Remove obstruction in air or water flow	Remove obstruction in air or water flow	Replace compressor	Test compressor efficiency	Replace valve	Replace valve	Replace valve	Fix feeler bulb	Check heat load	Tighten bolts or screws	Remove them	Choose AC of lager capacity or add the number of AC	Rectify piping so as not to contact each other or with external plate

2.Field Maintenance	Electrical Circuit														
Possible causes of trouble	Power failure	Blown fuse or varistor	Loose connections	Shorted or broken wires	Safety device opens	Faulty thermostat / room temperature sensor	Wrong setting place of temperature sensor	Faulty transformer	Shorted or open capacitor	Faulty magnetic contactor for compressor	Faulty magnetic contactor for fan	Low voltage	Faulty stepping motor	Shorted or grounded compressor	Shorted or grounded fan motor
Unit will not start	☆	☆	☆	☆	☆			☆							
Compressor will not start but fans run				☆		☆			☆	☆				☆	
Compressor and condenser (outdoor) fan will not start				☆		☆				☆					
Evaporator (indoor) fan will not start				☆					☆		☆				☆
Condenser (Outdoor) fan will not start				☆		☆			☆		☆				☆
Unit runs, but shortly stops										☆		☆			
Compressor short-cycles due to overload										☆		☆			
High discharge pressure															
Low discharge pressure															
High suction pressure															
Low suction pressure															
Unit runs continuously but insufficient cooling															
Too cool						☆	☆								
Compressor is noisy															
Horizontal louver can not revolve			☆	☆									☆		
Test method / remedy	Test voltage	Inspect fuse type & size	Inspect connections - tighten	Test circuits with tester	Test continuity of safety device	Test continuity of thermostat / sensor & wiring Place the temperature sensor at the central of the air inlet grille	Check control circuit with tester	Check capacitor with tester	Test continuity of coil & contacts	Test continuity of coil & contacts	Test voltage	Replace the stepping motor	Check resistance with multimeter	Check resistance with multimeter	

## 6. Quick Maintenance by Error Code

If you do not have the time to test which specific parts are faulty, you can directly change the required parts according to the error code.

You can find the parts to replace by error code in the following table.

Part requiring replacement	Error Code								
	E0	E1	E2	E3	E4	E5	E7/Eb	EC	F0
	EH00	EEL01	EH02	EH03	EH60	EH61	EH0b	EL0C	PC08
Indoor PCB	✓	✓	✓	✓	✓	✓	✓	✓	✗
Outdoor PCB	✗	✓	✗	✗	✗	✗	✗	✗	✓
Display board	✗	✗	✗	✗	✗	✗	✓	✗	✗
Indoor fan motor	✗	✗	✗	✓	✗	✗	✗	✗	✗
T1 sensor	✗	✗	✗	✗	✓	✗	✗	✗	✗
T2 Sensor	✗	✗	✗	✗	✗	✓	✗	✓	✗
Reactor	✗	✓	✗	✗	✗	✗	✗	✗	✗
Compressor	✗	✗	✗	✗	✗	✗	✗	✗	✓
Additional refrigerant	✗	✗	✗	✗	✗	✗	✗	✓	✗

Part requiring replacement	F1	F2	F3	F6	F4	F5	P0	P1	P2	P6	P4
	EC53	EC52	EC54	EC56	EC51	EC07	PC00	PC01	PC02	PC03	PC04
Indoor PCB	✗	✗	✗	✗	✗	✗	✗	✗	✗	✗	✗
Outdoor PCB	✓	✓	✓	✓	✓	✓	✓	✓	✓	✓	✓
Indoor fan motor	✗	✗	✗	✗	✗	✗	✗	✗	✗	✗	✗
Outdoor fan motor	✗	✗	✗	✗	✗	✓	✓	✗	✓	✗	✓
T3 Sensor	✗	✓	✗	✗	✗	✗	✗	✗	✗	✗	✗
T4 Sensor	✓	✗	✗	✗	✗	✗	✗	✗	✗	✗	✗
TP Sensor	✗	✗	✓	✗	✗	✗	✗	✗	✗	✗	✗
T2B Sensor	✗	✗	✗	✓	✗	✗	✗	✗	✗	✗	✗
Reactor	✗	✗	✗	✗	✗	✗	✗	✓	✗	✗	✗
Compressor	✗	✗	✗	✗	✗	✗	✓	✗	✗	✗	✓
IPM module board	✗	✗	✗	✗	✗	✗	✓	✓	✓	✗	✓
High pressure protector	✗	✗	✗	✗	✗	✗	✗	✗	✓	✗	✗
Low pressure protector	✗	✗	✗	✗	✗	✗	✗	✗	✗	✓	✗
Additional refrigerant	✗	✗	✗	✗	✗	✗	✗	✗	✗	✓	✗

**Note:** For certain models, outdoor PCB could not be removed separately. In this case, the outdoor electric control box should be replaced as a whole.

## 7. Troubleshooting by Error Code

### 7.1 E0/EH 00 / F4/EC 51 (EEPROM parameter error diagnosis and solution)

**Description:** Indoor or outdoor PCB main chip does not receive feedback from EEPROM chip.

**Recommended parts to prepare:**

- Indoor PCB
- Outdoor PCB

**Troubleshooting and repair:**

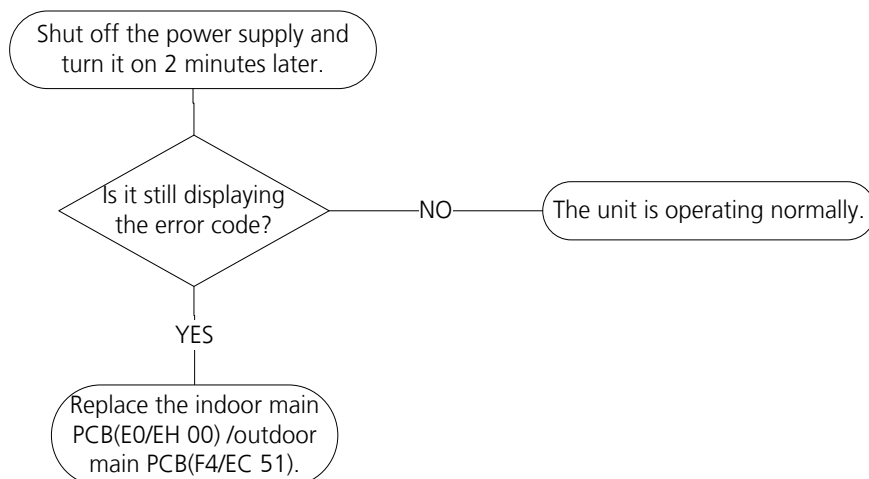

**Remarks:**

**EEPROM:** A read-only memory whose contents can be erased and reprogrammed using a pulsed voltage.

The location of the EEPROM chip on the indoor and outdoor PCB is shown in the following two images:

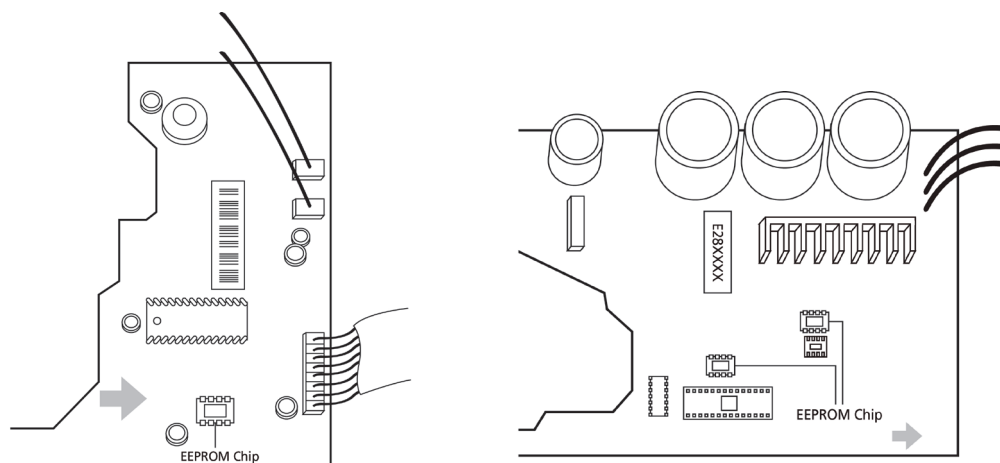

**Note:** For certain models, outdoor PCB could not be removed separately. In this case, the outdoor electric control box should be replaced as a whole. This pictures are only for reference, actual appearance may vary.

Troubleshooting and repair of compressor driven chip EEPROM parameter error and communication error between outdoor main chip and compressor driven chip are same as F4/EC 51.



## 7.2 E1/EL 01 (Indoor and outdoor unit communication error diagnosis and solution)

**Description:** Indoor unit can not communicate with outdoor unit

**Recommended parts to prepare:**

- Indoor PCB
- Outdoor PCB
- Short-circuited component

**Troubleshooting and repair:**

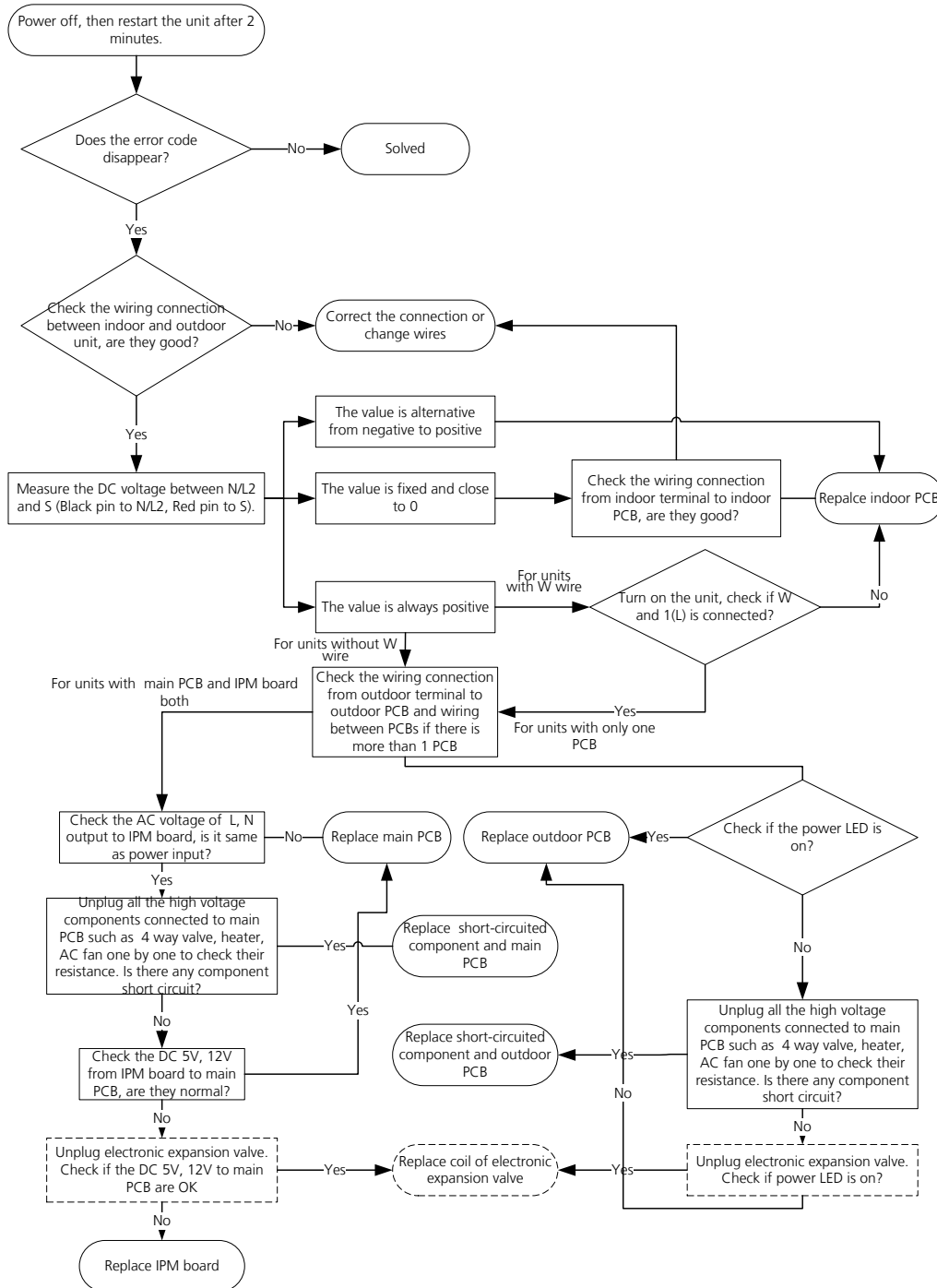

**Note:** For certain models, outdoor PCB could not be removed separately. In this case, the outdoor electric control box should be replaced as a whole.

---

**Remarks:**

- Use a multimeter to test the DC voltage between 2 port(or S or L2 port) and 3 port(or N or S port) of outdoor unit. The red pin of multimeter connects with 2 port(or S or L2 port) while the black pin is for 3 port(or N or S port).
- When AC is normal running, the voltage is moving alternately as positive values and negative values
- If the outdoor unit has malfunction, the voltage has always been the positive value.
- While if the indoor unit has malfunction, the voltage has always been a certain value.

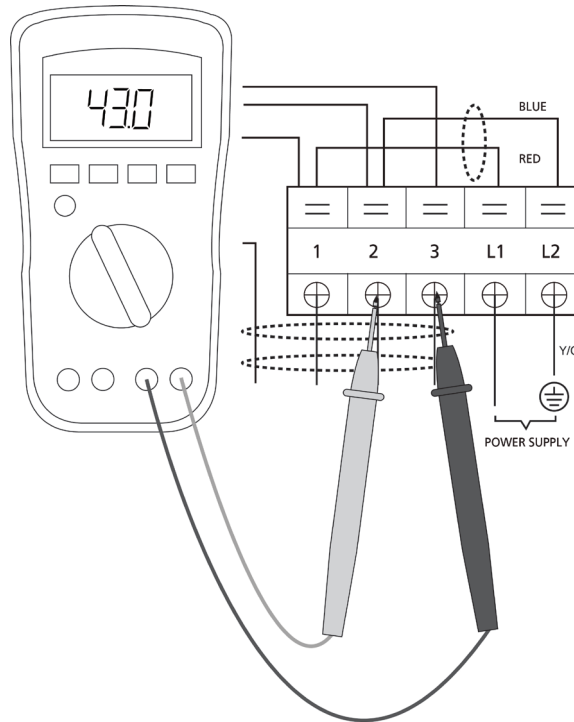

**S and N  
or  
L2 and S  
or  
2 and 3**

- Use a multimeter to test the resistance of the reactor which does not connect with capacitor.
- The normal value should be around zero ohm. Otherwise, the reactor must have malfunction.

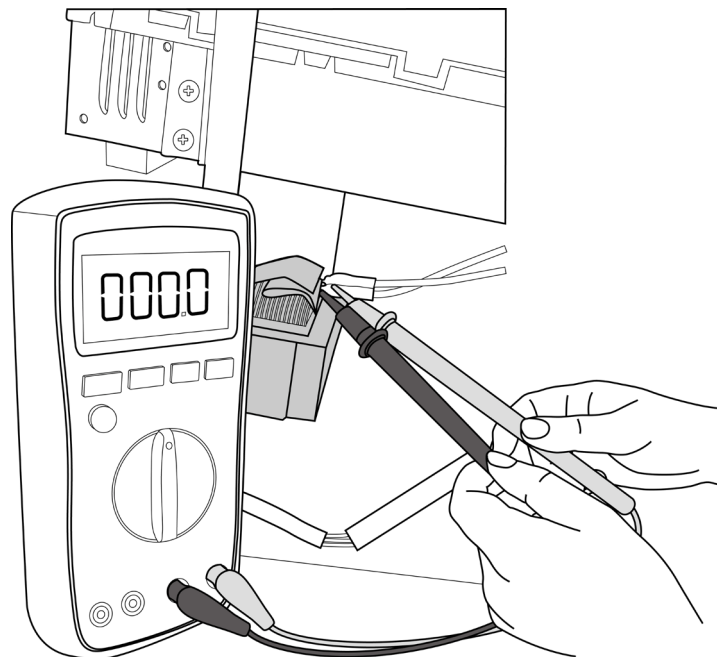

**Note:** The picture and the value are only for reference, actual condition and specific value may vary.

---

### 7.3 E2/EH 02 (Zero crossing detection error diagnosis and solution)

**Description:** When PCB does not receive zero crossing signal feedback for 4 minutes or the zero crossing signal time interval is abnormal.

**Recommended parts to prepare:**

- Connection wires
- PCB

**Troubleshooting and repair:**

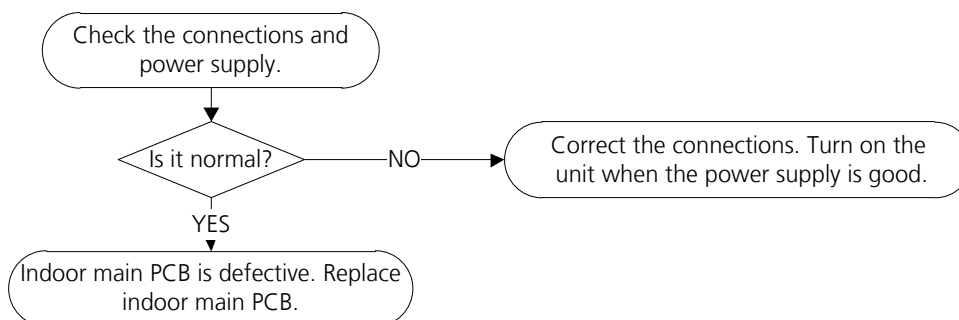

**Note:** E2/EH 02 zero crossing detection error is only valid for the unit with AC fan motor, for other models, this error is invalid.

## 7.4 E3/EH 03 / F5/EC 07 (Fan speed is operating outside of normal range diagnosis and solution)

**Description:** When indoor / outdoor fan speed keeps too low or too high for a certain time, the LED displays the failure code and the AC turns off.

### Recommended parts to prepare:

- Connection wires
- Fan assembly
- Fan motor
- PCB

### Troubleshooting and repair:

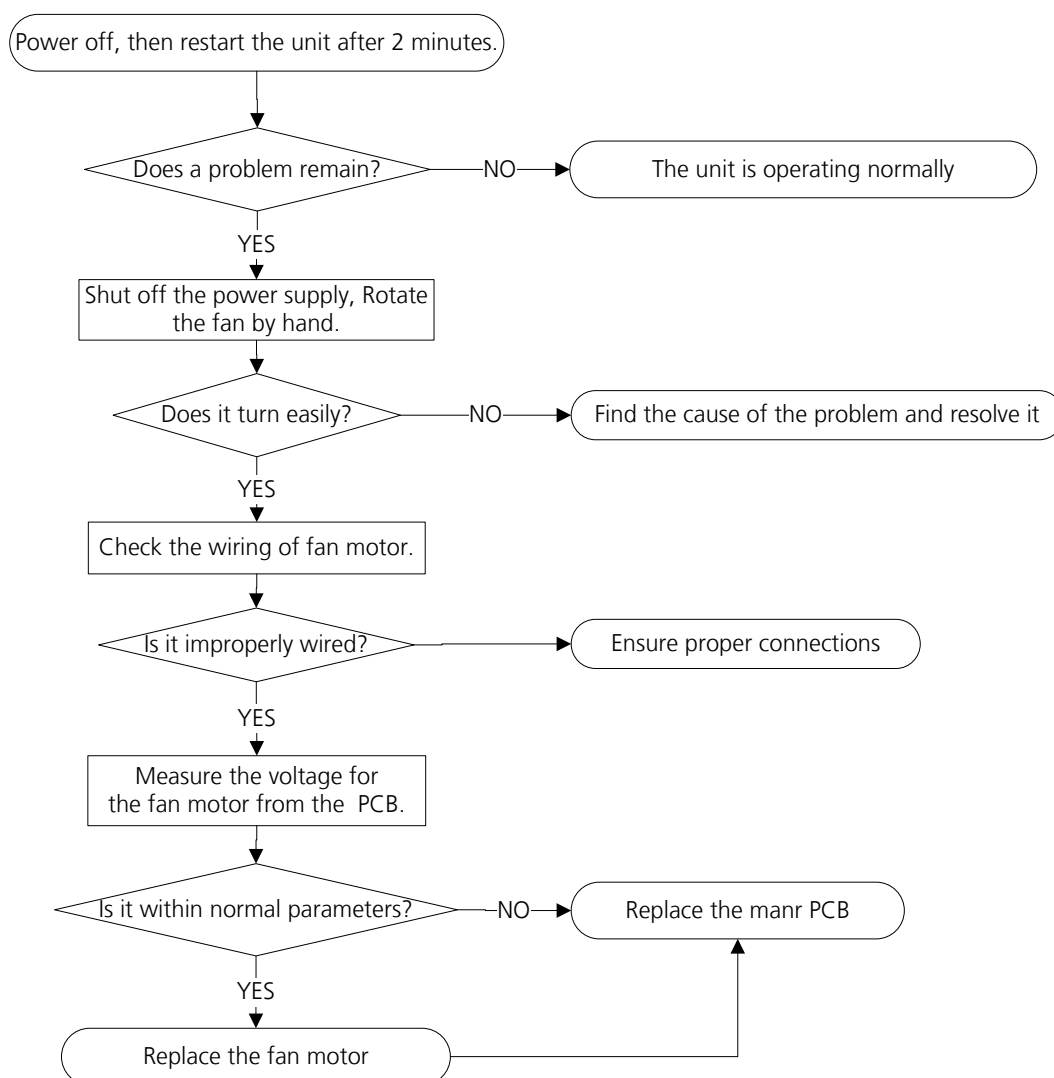

**Note:** For certain models, outdoor PCB could not be removed separately. In this case, the outdoor electric control box should be replaced as a whole.

---

## Index:

### 1. Indoor or Outdoor DC Fan Motor(control chip is in fan motor)

Power on and when the unit is in standby, measure the voltage of pin1-pin3, pin4-pin3 in fan motor connector. If the value of the voltage is not in the range showing in below table, the PCB must has problems and need to be replaced.

- DC motor voltage input and output (voltage: 220-240V~):

No.	Color	Signal	Voltage
1	Red	Vs/Vm	280V~380V
2	---	---	---
3	Black	GND	0V
4	White	Vcc	14-17.5V
5	Yellow	Vsp	0~5.6V
6	Blue	FG	14-17.5V

- DC motor voltage input and output (voltage: 115V~):

No.	Color	Signal	Voltage
1	Red	Vs/Vm	140V~190V
2	---	---	---
3	Black	GND	0V
4	White	Vcc	14-17.5V
5	Yellow	Vsp	0~5.6V
6	Blue	FG	14-17.5V

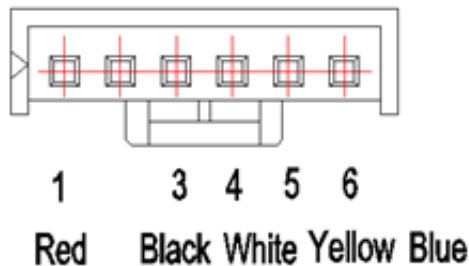

### 2. Outdoor DC Fan Motor (control chip is in outdoor PCB)

Release the UVW connector. Measure the resistance of U-V, U-W, V-W. If the resistance is not equal to each other, the fan motor must has problems and need to be replaced. otherwise the PCB must has problems and need to be replaced.

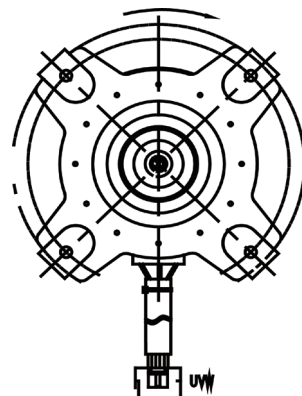

---

### 3. Indoor AC Fan Motor

Power on and set the unit running in fan mode at high fan speed. After running for 15 seconds, measure the voltage of pin1 and pin2. If the value of the voltage is less than 100V(208~240V power supply) or 50V (115V power supply), the PCB must has problems and need to be replaced.

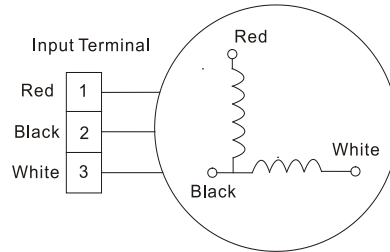

## 7.5 E4/EH 60/E5/EH 61/F1/EC 53/F2/EC 52/F3/EC 54/F6/EC56 (Open circuit or short circuit of temperature sensor diagnosis and solution)

**Description:** If the sampling voltage is lower than 0.06V or higher than 4.94V, the LED displays the failure code.

**Recommended parts to prepare:**

- Connection wires
- Sensors
- PCB

**Troubleshooting and repair:**

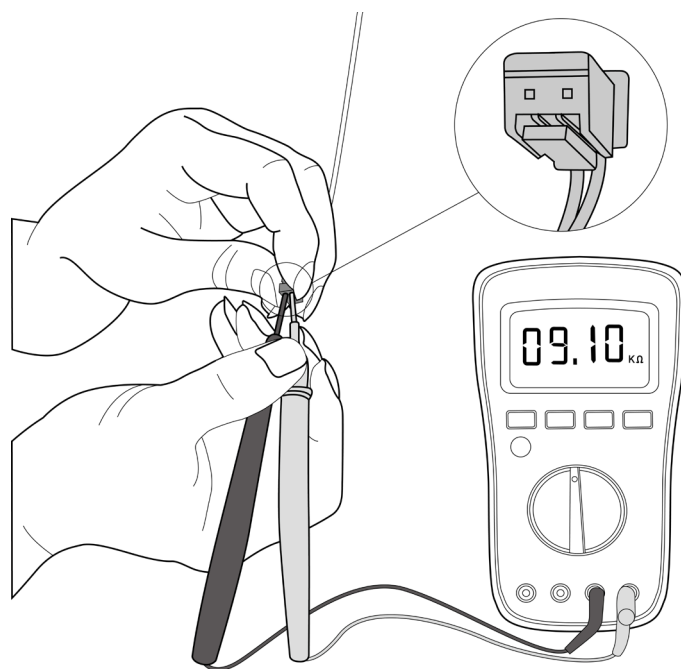
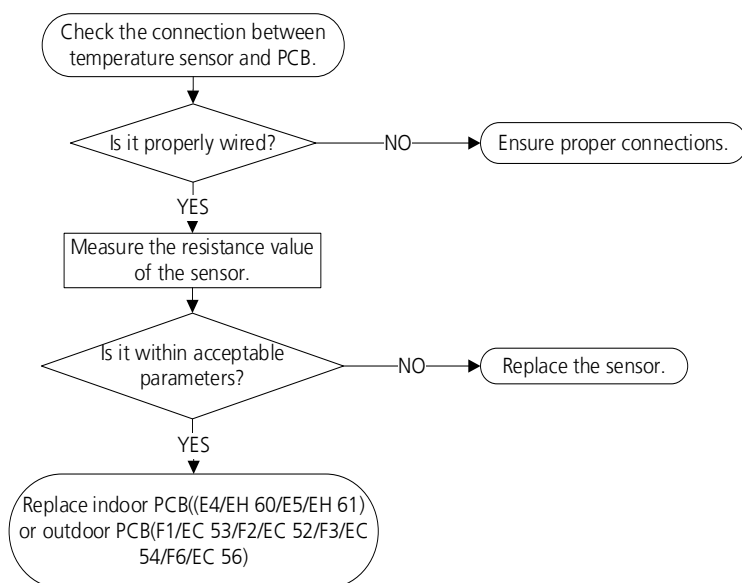

**Note:** For certain models, outdoor PCB could not be removed separately. In this case, the outdoor electric control box should be replaced as a whole. This picture and the value are only for reference, actual appearance and value may vary. For certain models, outdoor unit uses combination sensor, T3,T4 and TP are the same of sensor.

---

## 7.6 E7/EH 0b (Indoor PCB / Display board communication error diagnosis and solution)

**Description:** Indoor PCB does not receive feedback from the display board.

**Recommended parts to prepare:**

- Communication wire
- Indoor PCB
- Display board

**Troubleshooting and repair:**

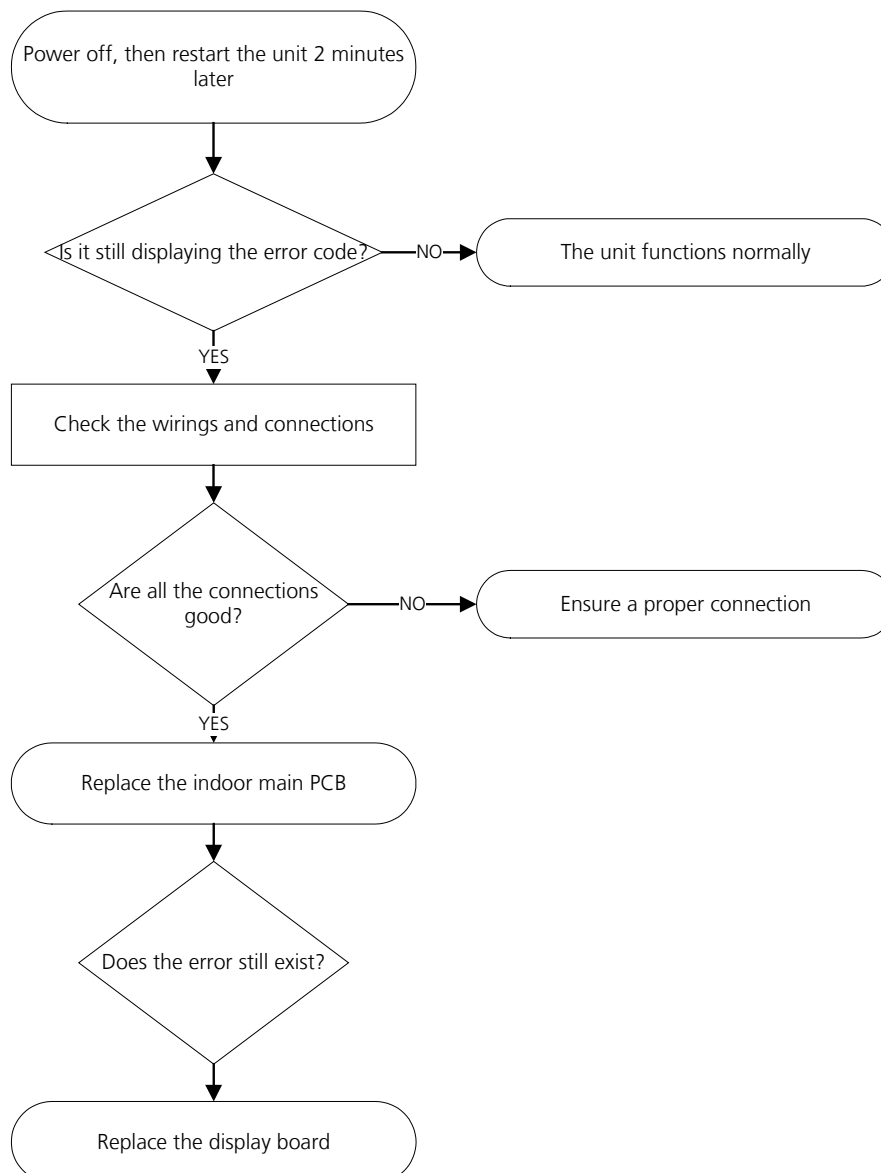



## 7.7 EC/EL 0C (Refrigerant Leakage Detection diagnosis and solution)

**Description:** Define the evaporator coil temperature T2 of the compressor just starts running as Tcool.

In the beginning 5 minutes after the compressor starts up, if  $T2 < T_{cool} - 1^{\circ}\text{C}$  ( $1.8^{\circ}\text{F}$ ) does not keep continuous 4 seconds and compressor running frequency higher than 50Hz does not keep for 3 minutes, and this situation happens 3 times, the LED displays the failure code and the AC turns off.

### Recommended parts to prepare:

- T2 sensor
- Indoor PCB
- Additional refrigerant

### Troubleshooting and repair:

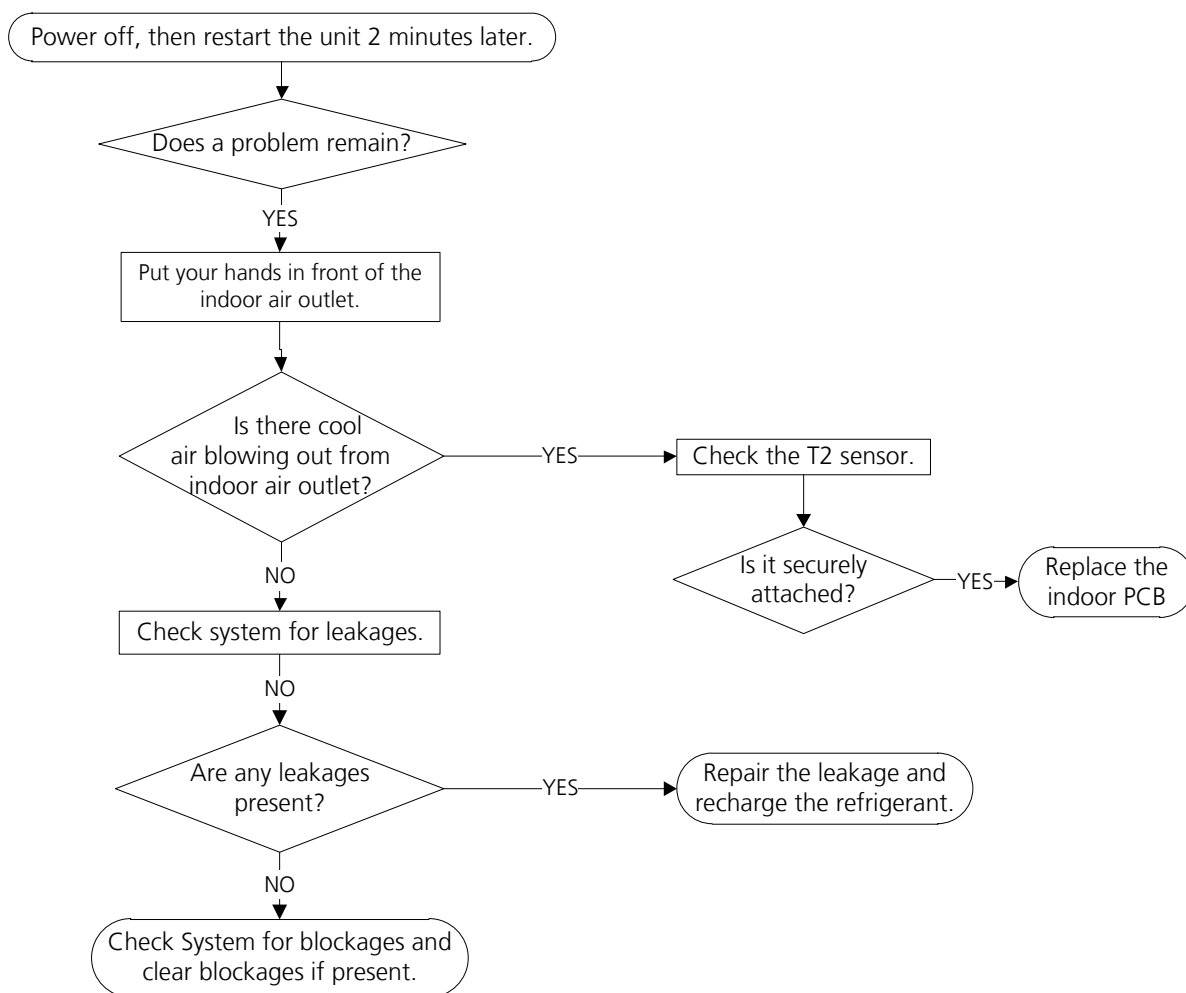

## 7.8 F0/PC 08 (Overload current protection diagnosis and solution)

**Description:** An abnormal current rise is detected by checking the specified current detection circuit.

**Recommended parts to prepare:**

- Outdoor PCB
- Connection wires
- Compressor

**Troubleshooting and repair:**

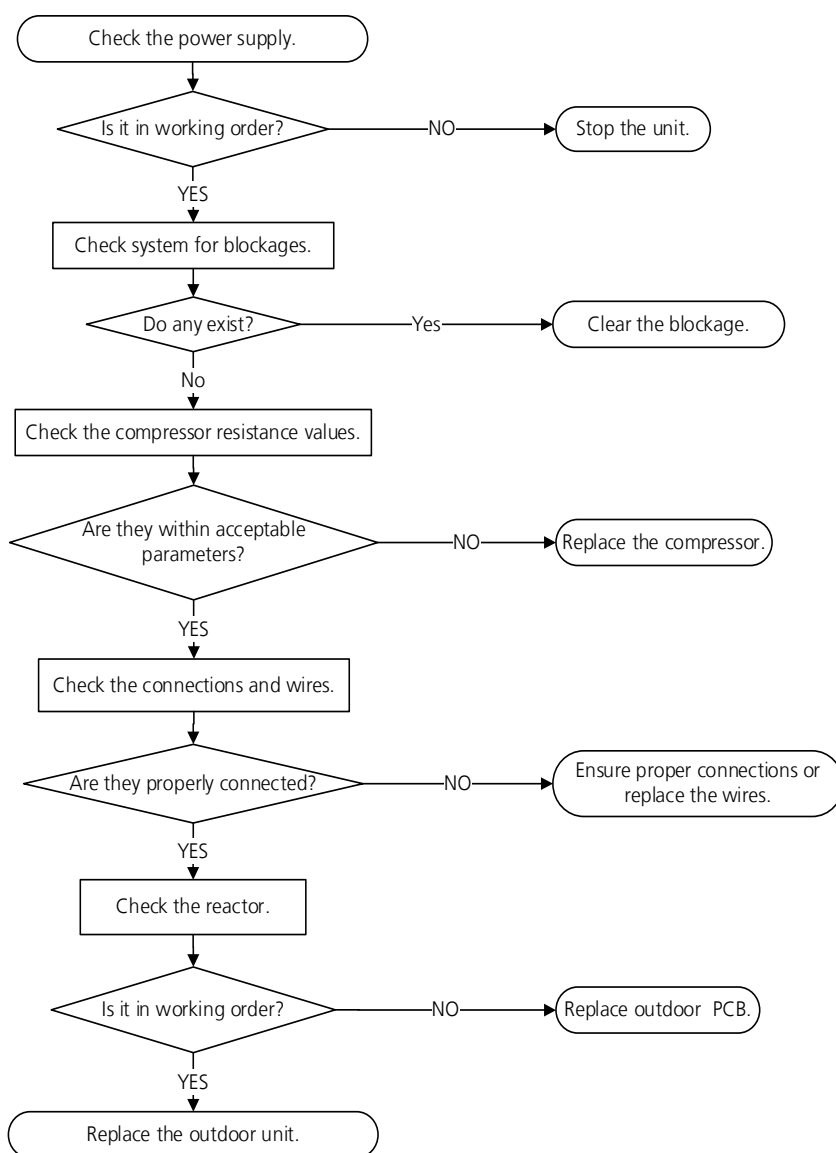

**Note:** For certain models, outdoor PCB could not be removed separately. In this case, the outdoor electric control box should be replaced as a whole.

## 7.9 P0/PC 00(IPM malfunction or IGBT over-strong current protection diagnosis and solution)

**Description:** When the voltage signal the IPM sends to the compressor drive chip is abnormal, the LED displays the failure code and the AC turns off.

### Recommended parts to prepare:

- Connection wires
- IPM module board
- Outdoor fan assembly
- Compressor
- Outdoor PCB

### Troubleshooting and repair:

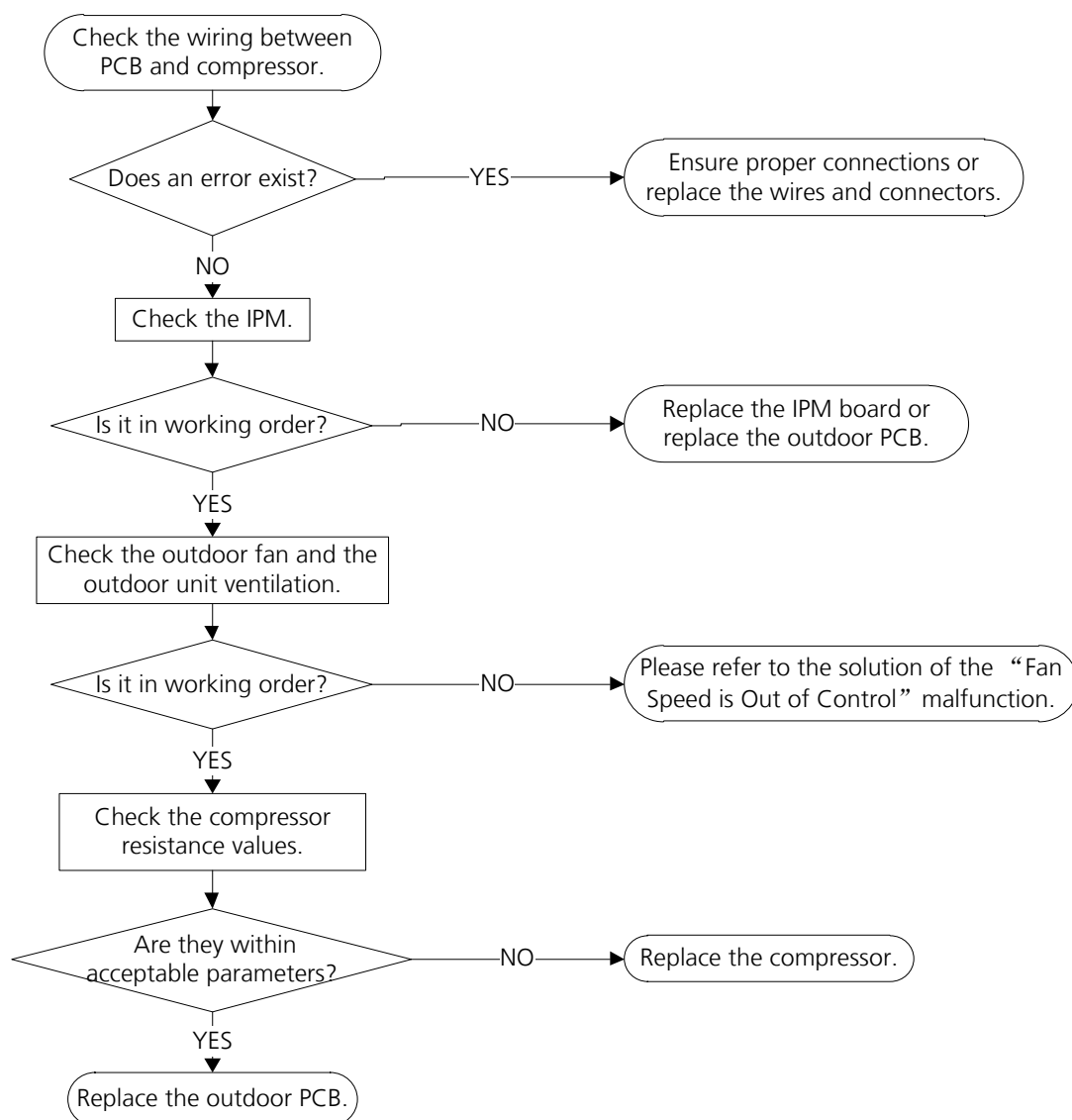

**Note:** For certain models, outdoor PCB could not be removed separately. In this case, the outdoor electric control box should be replaced as a whole.

## 7.10 P1/PC 01(Over voltage or too low voltage protection diagnosis and solution)

**Description:** Abnormal increases or decreases in voltage are detected by checking the specified voltage detection circuit.

### Recommended parts to prepare:

- Power supply wires
- IPM module board
- PCB
- Reactor

### Troubleshooting and repair:

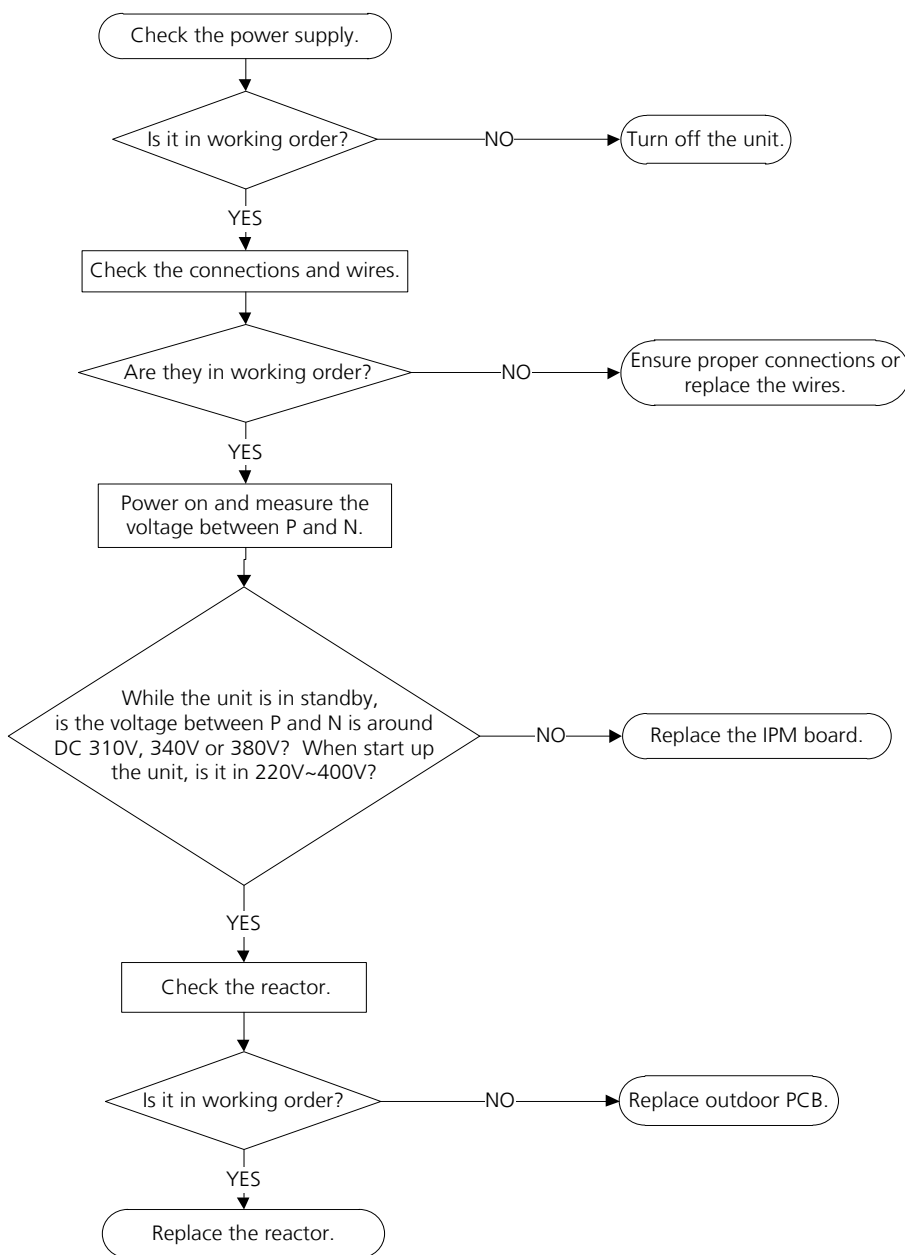

**Note:** For certain models, outdoor PCB could not be removed separately. In this case, the outdoor electric control box should be replaced as a whole.

---

## 7.11 P2/PC 02(High temperature protection of IPM module or High pressure protection diagnosis and solution)

**Description:** If the temperature of IPM module is higher than a certain value, the LED displays the failure code.

For some models with high pressure switch, outdoor pressure switch cut off the system because high pressure is higher than 4.4 MPa, the LED displays the failure code.

### Recommended parts to prepare:

- Connection wires
- Outdoor PCB
- IPM module board
- High pressure protector
- System blockages

### Troubleshooting and repair:

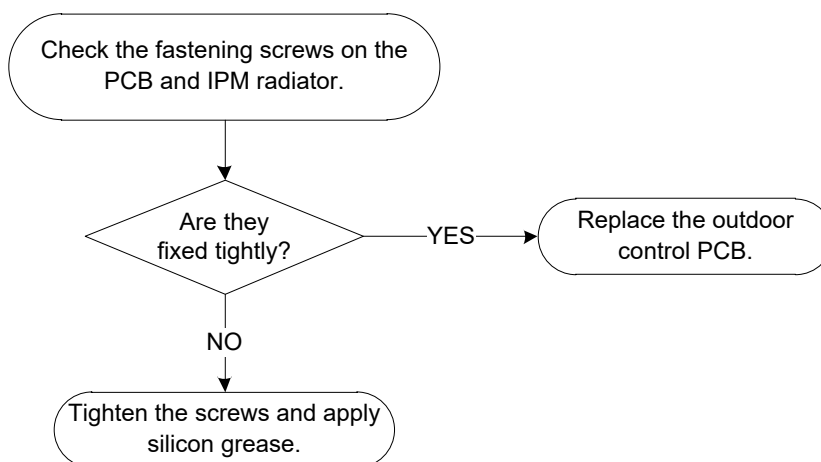

**Note:** For certain models, outdoor PCB could not be removed separately. In this case, the outdoor electric control box should be replaced as a whole.

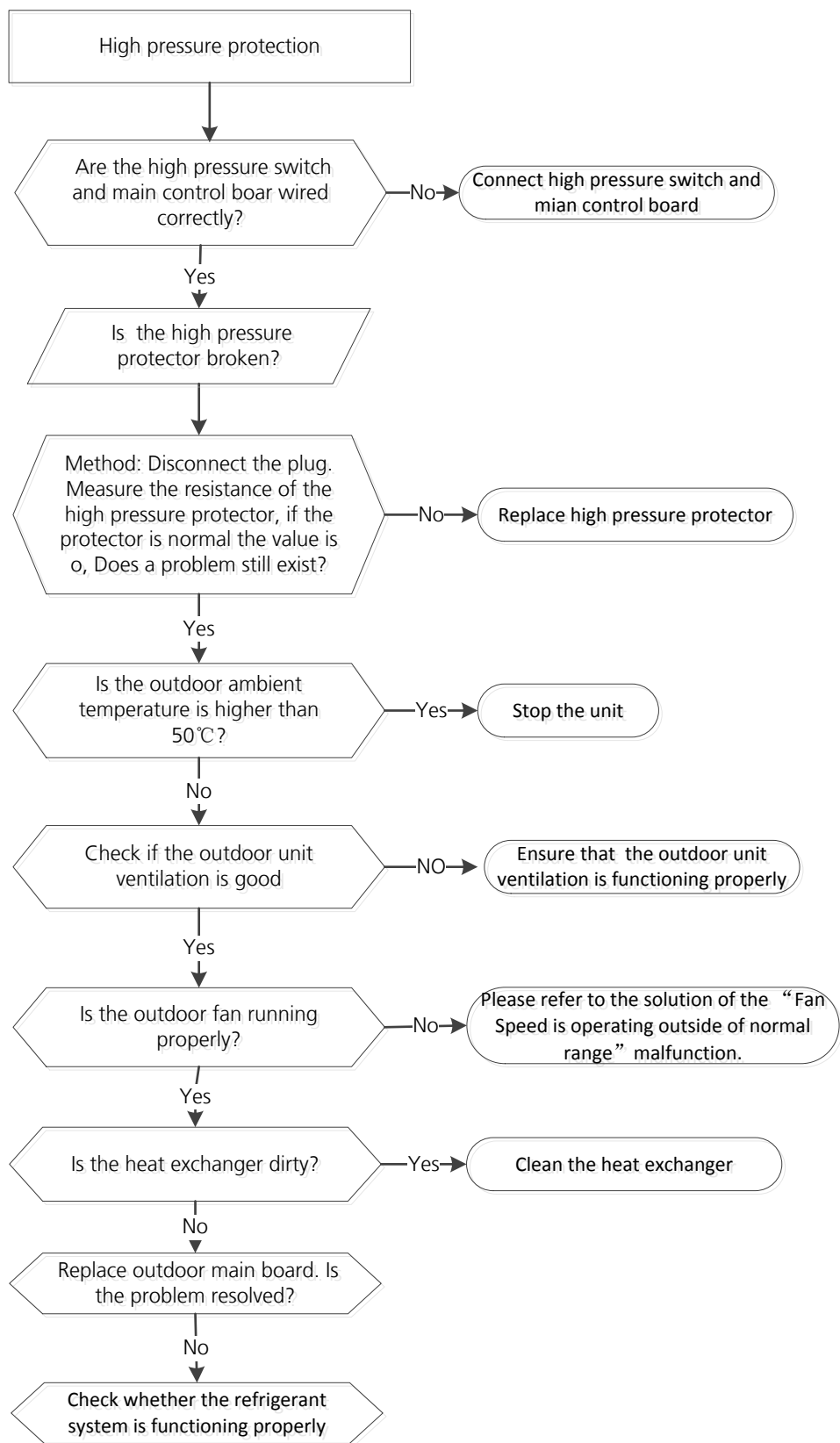

## 7.12 P4/PC 04(Inverter compressor drive error diagnosis and solution)

**Description:** An abnormal inverter compressor drive is detected by a special detection circuit, including communication signal detection, voltage detection, compressor rotation speed signal detection and so on.

### Recommended parts to prepare:

- Connection wires
- IPM module board
- Outdoor fan assembly
- Compressor
- Outdoor PCB

### Troubleshooting and repair:

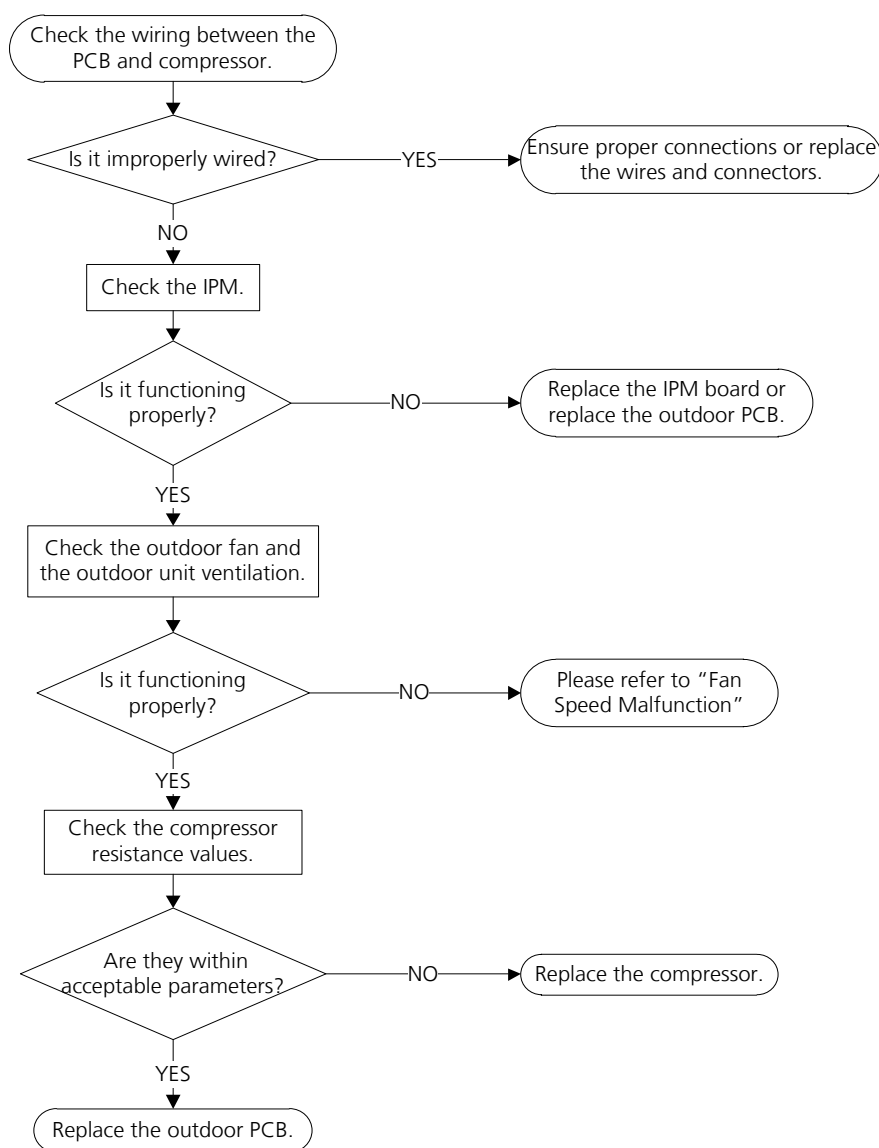

**Note:** For certain models, outdoor PCB could not be removed separately. In this case, the outdoor electric control box should be replaced as a whole.

---

### 7.13 PC 03(Low pressure protection diagnosis and solution)

**Description:** Outdoor pressure switch cut off the system because low pressure is lower than 0.13 MPa, the LED displays the failure code.

**Recommended parts to prepare:**

- Connection wires
- Outdoor PCB
- Low pressure protector
- Refrigerant

**Troubleshooting and repair:**



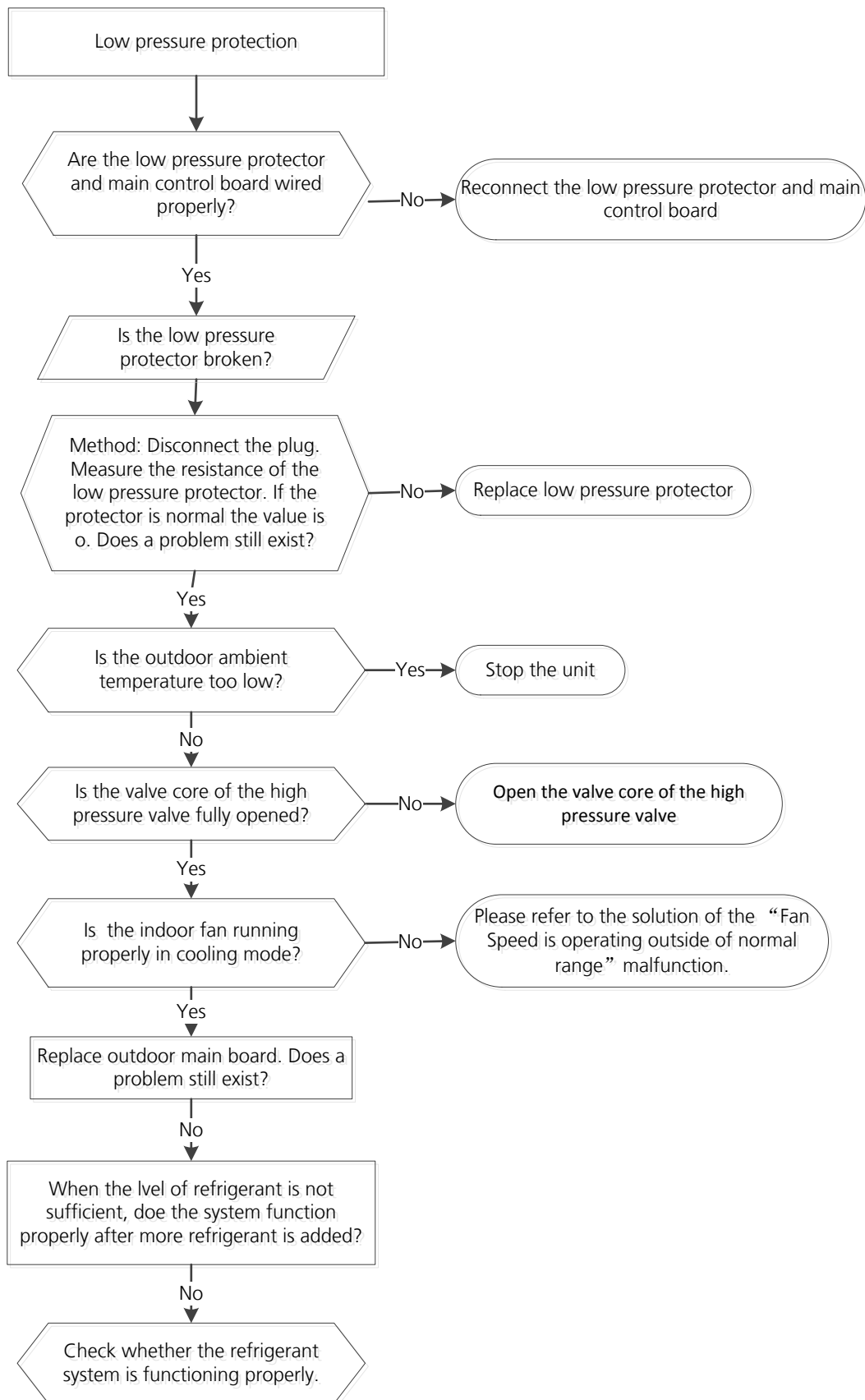

## 8. Check Procedures

### 8.1 Temperature Sensor Check

#### WARNING

**Be sure to turn off all power supplies or disconnect all wires to avoid electric shock. Operate after compressor and coil have returned to normal temperature in case of injury.**

1. Disconnect the temperature sensor from PCB (Refer to Chapter 5&6. Indoor&Outdoor Unit Disassembly).
2. Measure the resistance value of the sensor using a multi-meter.
3. Check corresponding temperature sensor resistance value table (Refer to Chapter 8. Appendix).

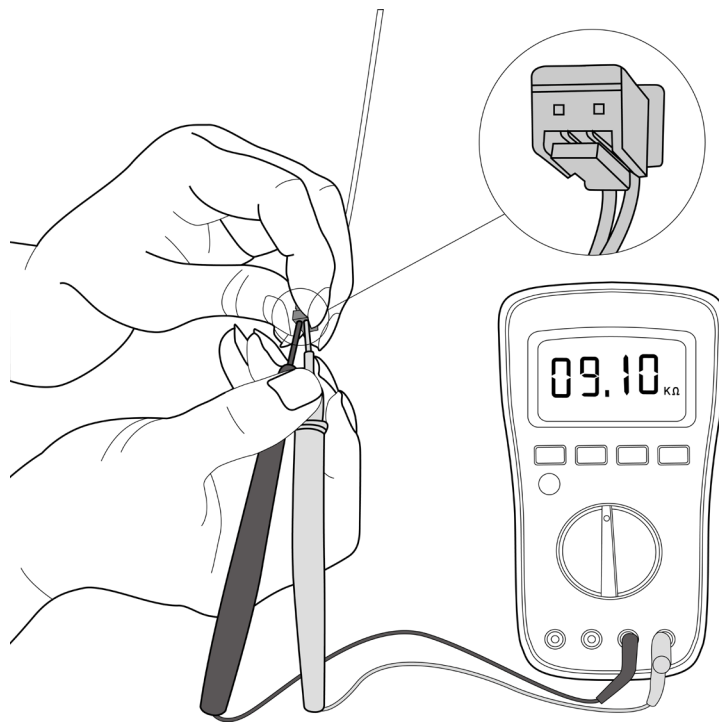

**Note: The picture and the value are only for reference, actual condition and specific value may vary.**

### .2 Compressor Check

1. Disconnect the compressor power cord from outdoor PCB (Refer to Chapter 6. Outdoor Unit Disassembly).
2. Measure the resistance value of each winding using a multi-meter.
3. Check the resistance value of each winding in the following table.

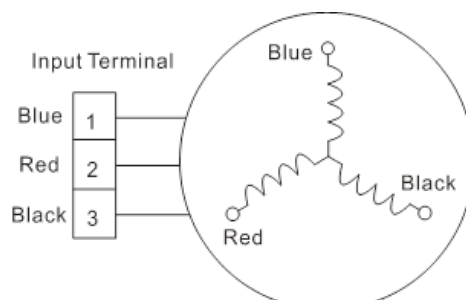

Resistance Value	KSK89D53UEZ	KSK89D29UEZD	KSN98D22UFZ	KSK103D33UEZ3	KTN150D30UFZA
Blue-Red	2.35Ω	1.99Ω	1.57Ω	2.02Ω	1.02Ω
Blue-Black					
Red-Black					

Resistance Value	KSM135D23UFZ	KSN140D21UFZ	KTF235D22UMT	KSK103D33UEZ3(YJ)	KTM240D57UMT
Blue-Red	1.72Ω	1.28Ω	0.75Ω	2.13Ω	0.62Ω
Blue-Black					
Red-Black					

Resistance Value	KSN140D58UFZ	KTM240D43UKT	KSN98D64UFZ3
Blue-Red	1.86Ω	1.03Ω	2.7Ω
Blue-Black			
Red-Black			

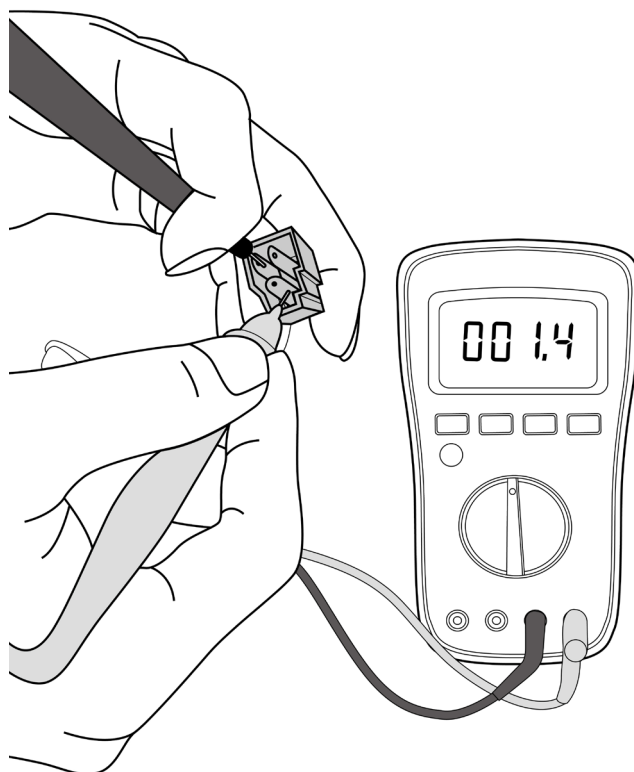

**Note:** The picture and the value are only for reference, actual condition and specific value may vary.

### 8.3 IPM Continuity Check

#### **⚠ WARNING**

**Electricity remains in capacitors even when the power supply is off. Ensure the capacitors are fully discharged before troubleshooting.**

1. Turn off outdoor unit and disconnect power supply.
2. Discharge electrolytic capacitors and ensure all energy-storage unit has been discharged.
3. Disassemble outdoor PCB or disassemble IPM board.
4. Measure the resistance value between P and U(V, W, N); U(V, W) and N.

Digital tester		Resistance value	Digital tester		Resistance value
(+)Red	(-)Black		(+)Red	(-)Black	
P	N	∞ (Several MΩ)	U	N	∞ (Several MΩ)
	U		V		
	V		W		
	W		-		

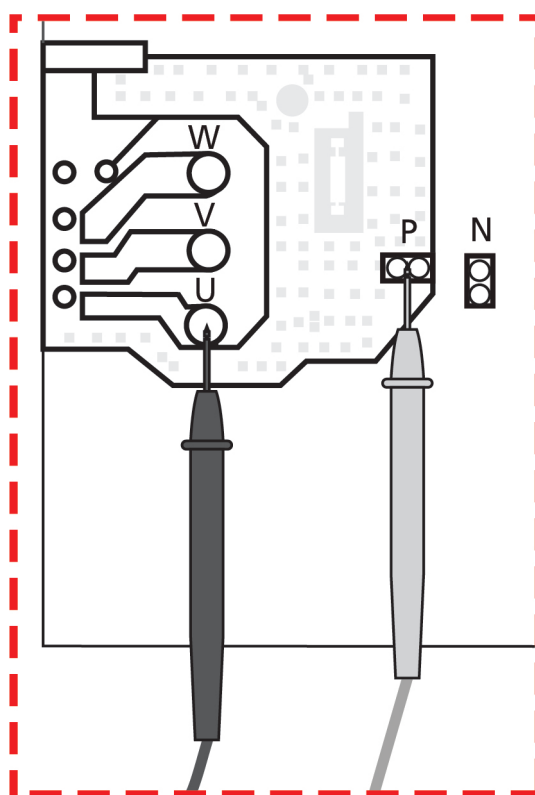

**Note:** The picture and the value are only for reference, actual condition and specific value may vary.

## 8.4 Fan Motor Check

1. Turn off outdoor unit and disconnect power supply
2. Disconnect outdoor fan motor power cord from outdoor PCB
3. Measure the resistance value between each windings.

The normal value of different motor show as follows:

Model	YKFG-13-4-38L YKFG-13-4-38L-4	YKFG-15-4-28-1	YKFG-20-4-10L	YKFG-20-4-5-11
Brand	Welling	Welling	Welling	Welling
Black – Red Main	345Ω	75Ω	269Ω	388Ω
Blue – Black AUX	348Ω	150Ω	224Ω	360Ω

Model	YKFG-20-4-5-19	YKFG-25-4-6-14	YKFG-28-4-3-7 YKFG-28-4-3-14	YKFG-28-4-6-5
Brand	Welling	Welling	Welling	Welling
Black – Red Main	444Ω	287Ω	231Ω	183.6Ω
Blue – Black AUX	470Ω	409Ω	414Ω	206Ω

Model	YKFG-45-4-13	YKFG-45-4-22 YKFG-45-4-22-13	YKFG-60-4-2-6
Brand	Dongfang	Welling	Welling
Black – Red Main	125.2Ω	168Ω	96Ω
Blue – Black AUX	83.8Ω	141Ω	96Ω

---

# Appendix

## Contents

i)	Temperature Sensor Resistance Value Table for T1, T2, T3, and T4 (°C – K) .....	2
ii)	Temperature Sensor Resistance Value Table for TP (for some units)(°C --K) .....	3
iii)	Pressure On Service Port .....	4

**i) Temperature Sensor Resistance Value Table for T1,T2,T3 and T4 (°C – K)**

°C	°F	K Ohm	°C	°F	K Ohm	°C	°F	K Ohm	°C	°F	K Ohm
-20	-4	115.266	20	68	12.6431	60	140	2.35774	100	212	0.62973
-19	-2	108.146	21	70	12.0561	61	142	2.27249	101	214	0.61148
-18	0	101.517	22	72	11.5	62	144	2.19073	102	216	0.59386
-17	1	96.3423	23	73	10.9731	63	145	2.11241	103	217	0.57683
-16	3	89.5865	24	75	10.4736	64	147	2.03732	104	219	0.56038
-15	5	84.219	25	77	10	65	149	1.96532	105	221	0.54448
-14	7	79.311	26	79	9.55074	66	151	1.89627	106	223	0.52912
-13	9	74.536	27	81	9.12445	67	153	1.83003	107	225	0.51426
-12	10	70.1698	28	82	8.71983	68	154	1.76647	108	226	0.49989
-11	12	66.0898	29	84	8.33566	69	156	1.70547	109	228	0.486
-10	14	62.2756	30	86	7.97078	70	158	1.64691	110	230	0.47256
-9	16	58.7079	31	88	7.62411	71	160	1.59068	111	232	0.45957
-8	18	56.3694	32	90	7.29464	72	162	1.53668	112	234	0.44699
-7	19	52.2438	33	91	6.98142	73	163	1.48481	113	235	0.43482
-6	21	49.3161	34	93	6.68355	74	165	1.43498	114	237	0.42304
-5	23	46.5725	35	95	6.40021	75	167	1.38703	115	239	0.41164
-4	25	44	36	97	6.13059	76	169	1.34105	116	241	0.4006
-3	27	41.5878	37	99	5.87359	77	171	1.29078	117	243	0.38991
-2	28	39.8239	38	100	5.62961	78	172	1.25423	118	244	0.37956
-1	30	37.1988	39	102	5.39689	79	174	1.2133	119	246	0.36954
0	32	35.2024	40	104	5.17519	80	176	1.17393	120	248	0.35982
1	34	33.3269	41	106	4.96392	81	178	1.13604	121	250	0.35042
2	36	31.5635	42	108	4.76253	82	180	1.09958	122	252	0.3413
3	37	29.9058	43	109	4.5705	83	181	1.06448	123	253	0.33246
4	39	28.3459	44	111	4.38736	84	183	1.03069	124	255	0.3239
5	41	26.8778	45	113	4.21263	85	185	0.99815	125	257	0.31559
6	43	25.4954	46	115	4.04589	86	187	0.96681	126	259	0.30754
7	45	24.1932	47	117	3.88673	87	189	0.93662	127	261	0.29974
8	46	22.5662	48	118	3.73476	88	190	0.90753	128	262	0.29216
9	48	21.8094	49	120	3.58962	89	192	0.8795	129	264	0.28482
10	50	20.7184	50	122	3.45097	90	194	0.85248	130	266	0.2777
11	52	19.6891	51	124	3.31847	91	196	0.82643	131	268	0.27078
12	54	18.7177	52	126	3.19183	92	198	0.80132	132	270	0.26408
13	55	17.8005	53	127	3.07075	93	199	0.77709	133	271	0.25757
14	57	16.9341	54	129	2.95896	94	201	0.75373	134	273	0.25125
15	59	16.1156	55	131	2.84421	95	203	0.73119	135	275	0.24512
16	61	15.3418	56	133	2.73823	96	205	0.70944	136	277	0.23916
17	63	14.6181	57	135	2.63682	97	207	0.68844	137	279	0.23338
18	64	13.918	58	136	2.53973	98	208	0.66818	138	280	0.22776
19	66	13.2631	59	138	2.44677	99	210	0.64862	139	282	0.22231

**ii) Temperature Sensor Resistance Value Table for TP(for some units) (°C --K)**

°C	°F	K Ohm	°C	°F	K Ohm	°C	°F	K Ohm	°C	°F	K Ohm
°C	°F	K Ohm	°C	°F	K Ohm	°C	°F	K Ohm	°C	°F	K Ohm
-20	-4	542.7	20	68	68.66	60	140	13.59	100	212	3.702
-19	-2	511.9	21	70	65.62	61	142	13.11	101	214	3.595
-18	0	483	22	72	62.73	62	144	12.65	102	216	3.492
-17	1	455.9	23	73	59.98	63	145	12.21	103	217	3.392
-16	3	430.5	24	75	57.37	64	147	11.79	104	219	3.296
-15	5	406.7	25	77	54.89	65	149	11.38	105	221	3.203
-14	7	384.3	26	79	52.53	66	151	10.99	106	223	3.113
-13	9	363.3	27	81	50.28	67	153	10.61	107	225	3.025
-12	10	343.6	28	82	48.14	68	154	10.25	108	226	2.941
-11	12	325.1	29	84	46.11	69	156	9.902	109	228	2.86
-10	14	307.7	30	86	44.17	70	158	9.569	110	230	2.781
-9	16	291.3	31	88	42.33	71	160	9.248	111	232	2.704
-8	18	275.9	32	90	40.57	72	162	8.94	112	234	2.63
-7	19	261.4	33	91	38.89	73	163	8.643	113	235	2.559
-6	21	247.8	34	93	37.3	74	165	8.358	114	237	2.489
-5	23	234.9	35	95	35.78	75	167	8.084	115	239	2.422
-4	25	222.8	36	97	34.32	76	169	7.82	116	241	2.357
-3	27	211.4	37	99	32.94	77	171	7.566	117	243	2.294
-2	28	200.7	38	100	31.62	78	172	7.321	118	244	2.233
-1	30	190.5	39	102	30.36	79	174	7.086	119	246	2.174
0	32	180.9	40	104	29.15	80	176	6.859	120	248	2.117
1	34	171.9	41	106	28	81	178	6.641	121	250	2.061
2	36	163.3	42	108	26.9	82	180	6.43	122	252	2.007
3	37	155.2	43	109	25.86	83	181	6.228	123	253	1.955
4	39	147.6	44	111	24.85	84	183	6.033	124	255	1.905
5	41	140.4	45	113	23.89	85	185	5.844	125	257	1.856
6	43	133.5	46	115	22.89	86	187	5.663	126	259	1.808
7	45	127.1	47	117	22.1	87	189	5.488	127	261	1.762
8	46	121	48	118	21.26	88	190	5.32	128	262	1.717
9	48	115.2	49	120	20.46	89	192	5.157	129	264	1.674
10	50	109.8	50	122	19.69	90	194	5	130	266	1.632
11	52	104.6	51	124	18.96	91	196	4.849			
12	54	99.69	52	126	18.26	92	198	4.703			
13	55	95.05	53	127	17.58	93	199	4.562			
14	57	90.66	54	129	16.94	94	201	4.426			
15	59	86.49	55	131	16.32	95	203	4.294			
16	61	82.54	56	133	15.73	96	205	4.167			
17	63	78.79	57	135	15.16	97	207	4.045			
18	64	75.24	58	136	14.62	98	208	3.927			
19	66	71.86	59	138	14.09	99	210	3.812			



### iii) Pressure On Service Port

#### Cooling chart(R410A):

°F(°C)	ODU(DB)		0(-17)	5(-15)	15 (-9.44)	45 (7.22)	75 (23.89)	85 (29.44)	95 (35)	105 (40.56)	115 (46.11)	120 (48.89)
	IDU(DB/WB)											
BAR	70/59 (21.11/15)		6.4	6.5	7.3	8.0	8.2	7.8	8.1	8.6	10.1	10.6
	75/63 (23.89/17.22)		6.7	6.8	7.9	8.6	8.6	8.3	8.7	9.1	10.7	11.2
	80/67 (26.67/19.44)		7.1	7.2	8.5	9.5	9.3	8.9	9.1	9.6	11.2	11.9
	90/73 (32.22/22.78)		7.7	7.8	9.6	10.5	10.3	9.5	10.0	10.6	12.4	13.0
PSI	70/59 (21.11/15)		93	94	106	116	119	113	117	125	147	154
	75/63 (23.89/17.22)		97	99	115	125	124	120	126	132	155	162
	80/67 (26.67/19.44)		103	104	123	138	135	129	132	140	162	173
	90/73 (32.22/22.78)		112	113	139	152	149	138	145	154	180	189
MPa	70/59 (21.11/15)		0.64	0.65	0.73	0.8	0.82	0.78	0.81	0.86	1.01	1.06
	75/63 (23.89/17.22)		0.67	0.68	0.79	0.86	0.86	0.83	0.87	0.91	1.07	1.12
	80/67 (26.67/19.44)		0.71	0.72	0.85	0.95	0.93	0.89	0.91	0.96	1.12	1.19
	90/73 (32.22/22.78)		0.77	0.78	0.96	1.05	1.03	0.95	1	1.06	1.24	1.3

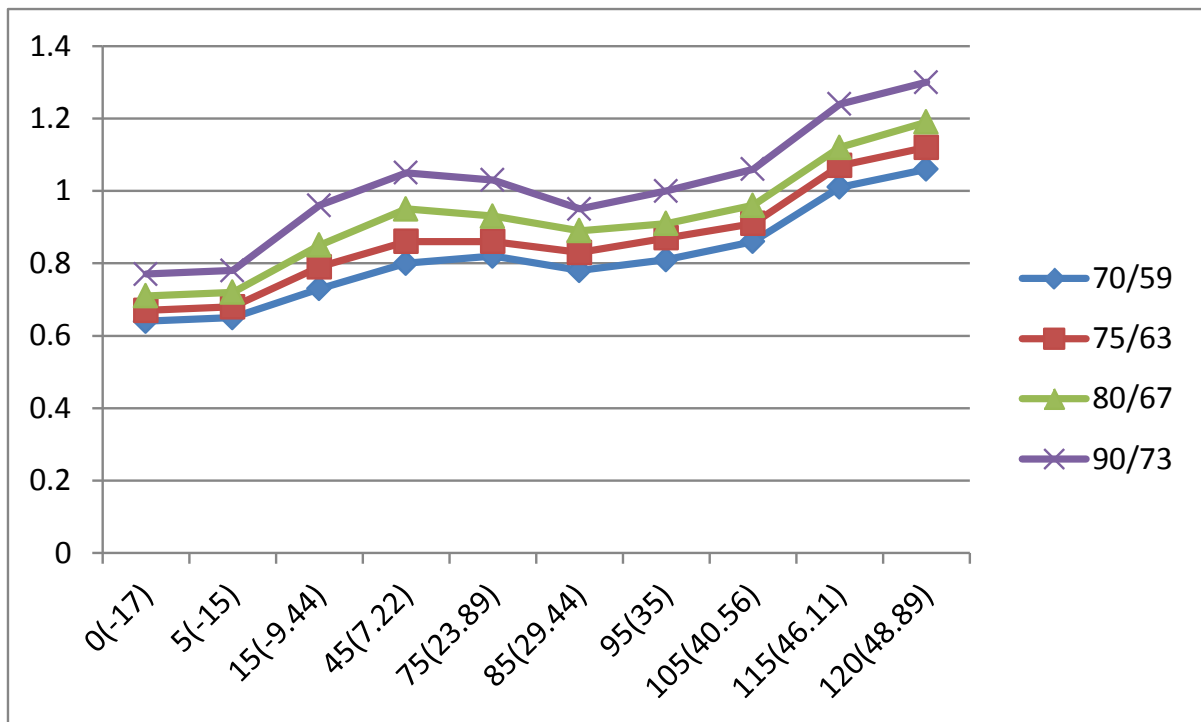

### Heating chart(R410A):

°F(°C)	ODU(DB/WB)	57/53 (13.89/11.67)	47/43 (8.33/6.11)	37/33 (2.78/0.56)	27/23 (-2.78/-5)	17/13 (-8.33/ -10.56)	0/-2 (-17/-19)	-17/-18 (-27/-28)
	IDU(DB)							
BAR	55(12.78)	30.3	28.5	25.3	22.8	20.8	18.5	16.5
	65(18.33)	32.5	30.0	26.6	25.4	23.3	20.5	19.0
	75(23.89)	33.8	31.5	27.8	26.3	24.9	21.5	20.0
PSI	55(12.78)	439	413	367	330	302	268	239
	65(18.33)	471	435	386	368	339	297	276
	75(23.89)	489	457	403	381	362	312	290
MPa	55(12.78)	3.03	2.85	2.53	2.28	2.08	1.85	1.65
	65(18.33)	3.25	3.00	2.66	2.54	2.33	2.05	1.90
	75(23.89)	3.38	3.15	2.78	2.63	2.49	2.15	2.00

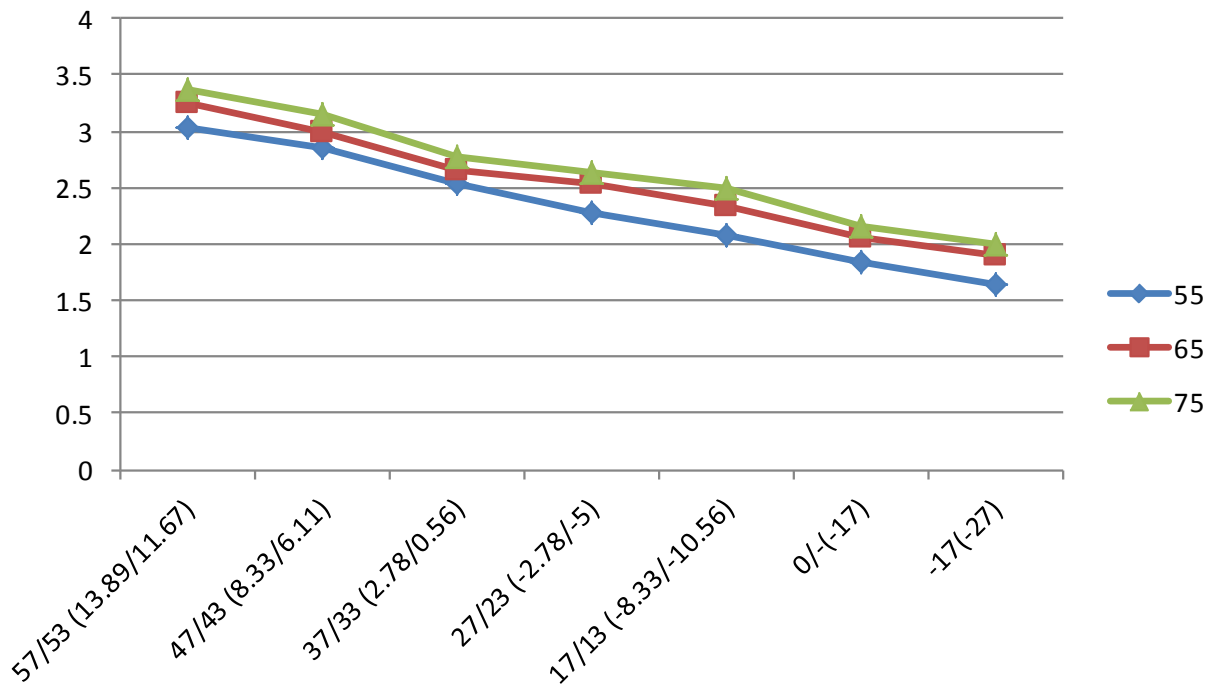

**Cooling chart(R22):**

°F(°C)	ODU(DB)		0(-17)	5(-15)	15(-9.44)	45(7.22)	75(23.89)	85(29.44)	95(35)	105(40.56)	115(46.11)	120(48.89)
	IDU(DB/WB)											
BAR	70/59 (21.11/15)		4.0	4.1	4.6	5.0	5.1	4.9	5.1	5.4	6.3	6.6
	75/63 (23.89/17.22)		4.2	4.3	4.9	5.4	5.4	5.2	5.4	5.7	6.7	7.0
	80/67 (26.67/19.44)		4.4	4.5	5.3	5.9	5.8	5.6	5.7	6.0	7.0	7.4
	90/73 (32.22/22.78)		4.8	4.9	6.0	6.6	6.4	5.9	6.3	6.6	7.8	8.1
PSI	70/59 (21.11/15)		58	59	67	73	74	71	74	78	91	96
	75/63 (23.89/17.22)		61	62	71	78	78	75	78	83	97	102
	80/67 (26.67/19.44)		64	65	77	86	84	81	83	87	102	107
	90/73 (32.22/22.78)		70	71	87	96	93	86	91	96	113	117
MPa	70/59 (21.11/15)		0.40	0.41	0.46	0.50	0.51	0.49	0.51	0.54	0.63	0.66
	75/63 (23.89/17.22)		0.42	0.43	0.49	0.54	0.54	0.52	0.54	0.57	0.67	0.70
	80/67 (26.67/19.44)		0.44	0.45	0.53	0.59	0.58	0.56	0.57	0.60	0.70	0.74
	90/73 (32.22/22.78)		0.48	0.49	0.60	0.66	0.64	0.59	0.63	0.66	0.78	0.81

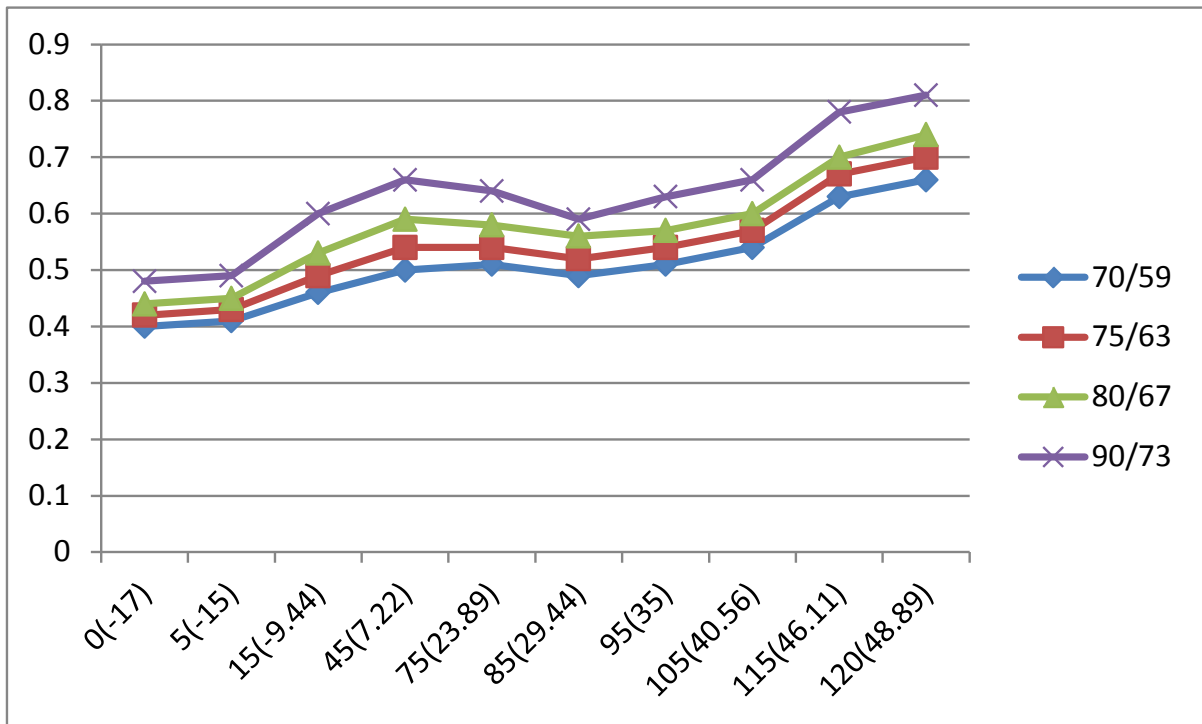

### Heating chart(R22):

°F(°C)	ODU(DB/WB)	57/53 (13.89/11.67)	47/43 (8.33/6.11)	37/33 (2.78/0.56)	27/23 (-2.78/-5)	17/13 (-8.33/ -10.56)	0/-2 (-17/-19)	-17/-18 (-27/-28)
	IDU(DB)							
BAR	55(12.78)	18.9	17.8	15.8	14.3	13.0	11.6	10.3
	65(18.33)	20.3	18.8	16.6	15.9	14.6	12.8	11.9
	75(23.89)	21.1	19.7	17.3	16.4	15.6	13.4	12.5
PSI	55(12.78)	274	258	229	207	189	168	149
	65(18.33)	294	273	241	231	212	186	172.6
	75(23.89)	306	286	251	238	226	194	181
MPa	55(12.78)	1.89	1.78	1.58	1.43	1.30	1.16	1.03
	65(18.33)	2.03	1.88	1.66	1.59	1.46	1.28	1.19
	75(23.89)	2.11	1.97	1.73	1.64	1.56	1.34	1.25

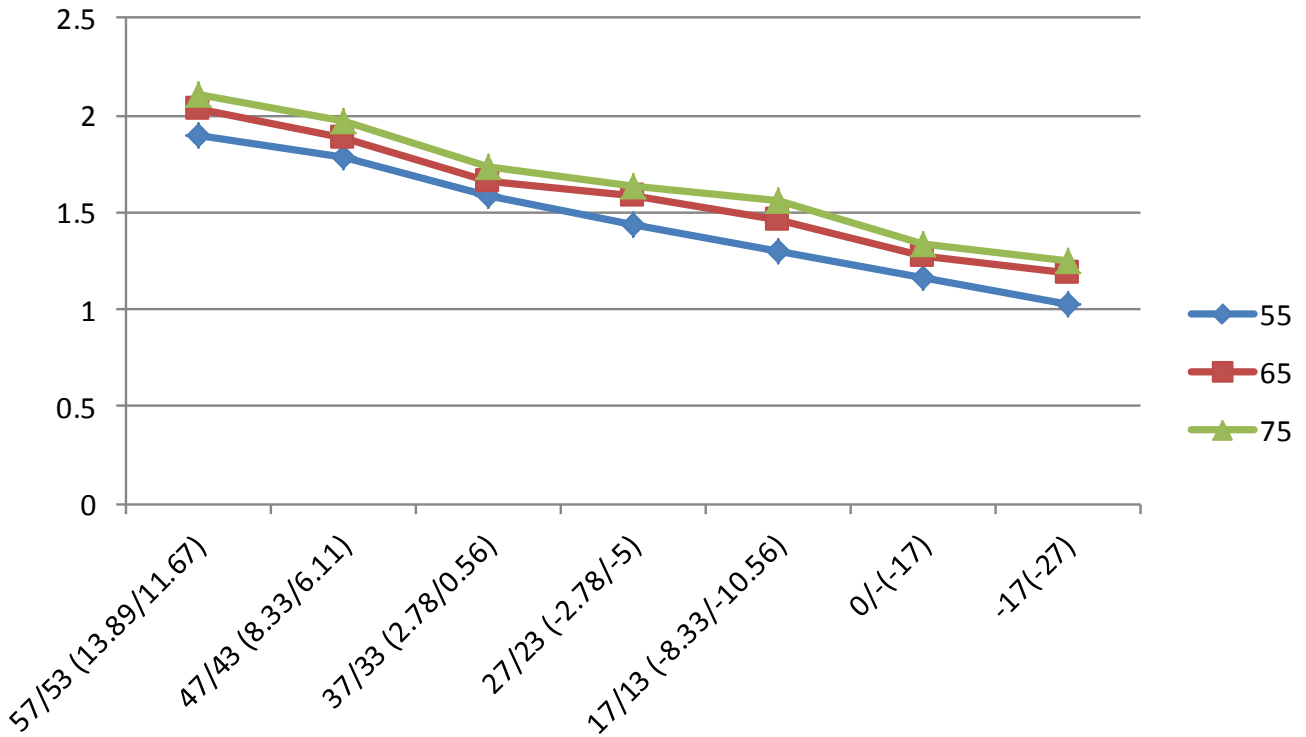

**Cooling chart(R32):**

°F(°C)	ODU(DB)		0(-17)	5(-15)	15(-9.44)	45(7.22)	75(23.89)	85(29.44)	95(35)	105(40.56)	115(46.11)	120(48.89)
	IDU(DB/WB)											
BAR	70/59 (21.11/15)		6.5	6.6	7.4	8.2	8.4	8.0	8.3	8.8	10.3	10.8
	75/63 (23.89/17.22)		6.8	6.9	8.1	8.8	8.8	8.5	8.9	9.3	10.9	11.4
	80/67 (26.67/19.44)		7.2	7.3	8.7	9.7	9.5	9.1	9.3	9.8	11.4	12.1
	90/73 (32.22/22.78)		7.9	8.0	9.8	10.7	10.5	9.7	10.2	10.8	12.6	13.3
PSI	70/59 (21.11/15)		95	96	108	118	121	115	119	128	150	157
	75/63 (23.89/17.22)		99	101	117	128	126	122	129	135	158	165
	80/67 (26.67/19.44)		105	106	125	141	138	132	135	143	165	176
	90/73 (32.22/22.78)		114	115	142	155	152	141	148	157	184	193
MPa	70/59 (21.11/15)		0.65	0.66	0.74	0.82	0.84	0.80	0.83	0.88	1.03	1.08
	75/63 (23.89/17.22)		0.68	0.69	0.81	0.88	0.88	0.85	0.89	0.93	1.09	1.14
	80/67 (26.67/19.44)		0.72	0.73	0.87	0.97	0.95	0.91	0.93	0.98	1.14	1.21
	90/73 (32.22/22.78)		0.79	0.80	0.98	1.07	1.05	0.97	1.02	1.08	1.26	1.33

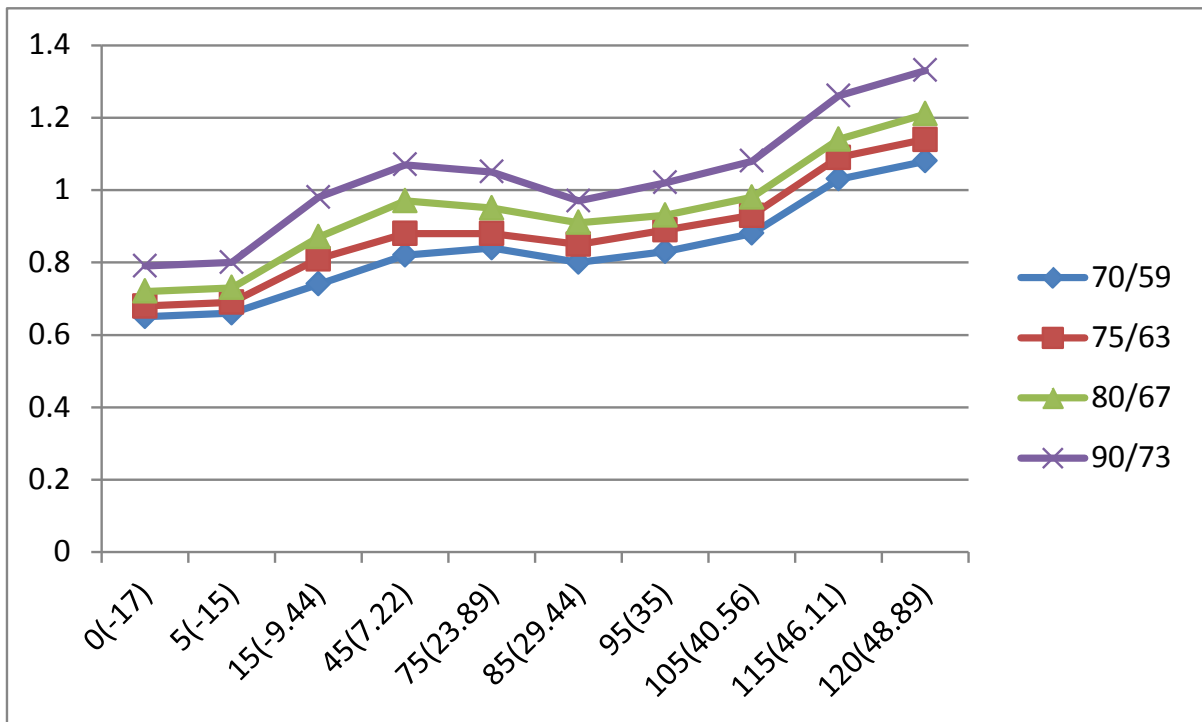

### Heating chart(R32):

°F(°C)	ODU(DB/WB)	57/53 (13.89/11.67)	47/43 (8.33/6.11)	37/33 (2.78/0.56)	27/23 (-2.78/-5)	17/13 (-8.33/- 10.56)	0/-2 (-17/-19)	-17/-18 (-27/-28)
	IDU(DB)							
BAR	55(12.78)	30.9	29.1	25.8	23.3	21.2	18.9	16.8
	65(18.33)	33.2	30.6	27.1	25.9	23.8	20.9	19.4
	75(23.89)	34.5	32.1	28.4	26.8	25.4	21.9	20.4
PSI	55(12.78)	448	421	374	337	308	273	244
	65(18.33)	480	444	394	375	346	303	282
	75(23.89)	499	466	411	389	369	318	296
MPa	55(12.78)	3.09	2.91	2.58	2.33	2.12	1.89	1.68
	65(18.33)	3.32	3.06	2.71	2.59	2.38	2.09	1.94
	75(23.89)	3.45	3.21	2.84	2.68	2.54	2.19	2.04

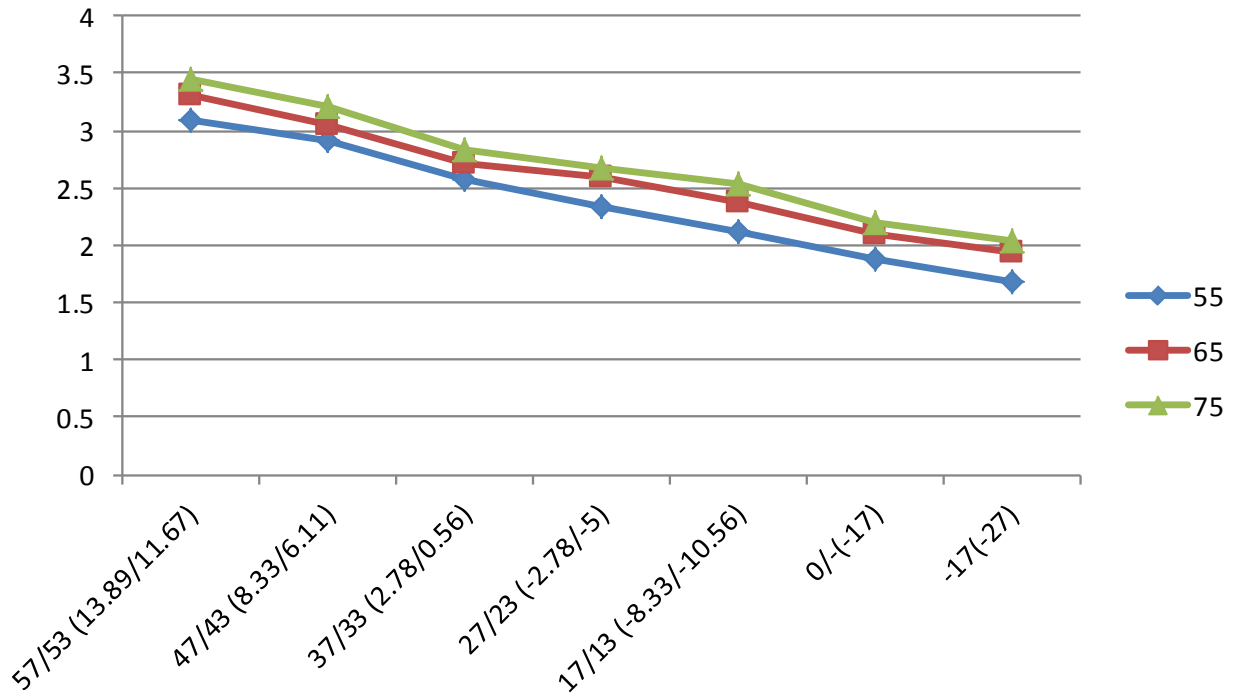

## System Pressure Table-R22

Pressure			Temperature		Pressure			Temperature	
Kpa	bar	PSI	°C	°F	Kpa	bar	PSI	°C	°F
100	1	14.5	-41.091	-41.964	1600	16	232	41.748	107.146
150	1.5	21.75	-32.077	-25.739	1650	16.5	239.25	43.029	109.452
200	2	29	-25.177	-13.319	1700	17	246.5	44.281	111.706
250	2.5	36.25	-19.508	-3.114	1750	17.5	253.75	45.506	113.911
300	3	43.5	-14.654	5.623	1800	18	261	46.706	116.071
350	3.5	50.75	-10.384	13.309	1850	18.5	268.25	47.882	118.188
400	4	58	-6.556	20.199	1900	19	275.5	49.034	120.261
450	4.5	65.25	-3.075	26.464	1950	19.5	282.75	50.164	122.295
500	5	72.5	0.124	32.223	2000	20	290	51.273	124.291
550	5.5	79.75	3.091	37.563	2050	20.5	297.25	52.361	126.250
600	6	87	5.861	42.550	2100	21	304.5	53.43	128.174
650	6.5	94.25	8.464	47.234	2150	21.5	311.75	54.48	130.064
700	7	101.5	10.92	51.656	2200	22	319	55.512	131.922
750	7.5	108.75	13.249	55.848	2250	22.5	326.25	56.527	133.749
800	8	116	15.465	59.837	2300	23	333.5	57.526	135.547
850	8.5	123.25	17.58	63.644	2350	23.5	340.75	58.508	137.314
900	9	130.5	19.604	67.287	2400	24	348	59.475	139.055
950	9.5	137.75	21.547	70.785	2450	24.5	355.25	60.427	140.769
1000	10	145	23.415	74.147	2500	25	362.5	61.364	142.455
1050	10.5	152.25	25.216	77.389	2550	25.5	369.75	62.288	144.118
1100	11	159.5	26.953	80.515	2600	26	377	63.198	145.756
1150	11.5	166.75	28.634	83.541	2650	26.5	384.25	64.095	147.371
1200	12	174	30.261	86.470	2700	27	391.5	64.98	148.964
1250	12.5	181.25	31.839	89.310	2750	27.5	398.75	65.852	150.534
1300	13	188.5	33.371	92.068	2800	28	406	66.712	152.082
1350	13.5	195.75	34.86	94.748	2850	28.5	413.25	67.561	153.610
1400	14	203	36.308	97.354	2900	29	420.5	68.399	155.118
1450	14.5	210.25	37.719	99.894	2950	29.5	427.75	69.226	156.607
1500	15	217.5	39.095	102.371	3000	30	435	70.042	158.076
1550	15.5	224.75	40.437	104.787					

## System Pressure Table-R410A

Pressure			Temperature		Pressure			Temperature	
Kpa	bar	PSI	°C	°F	Kpa	bar	PSI	°C	°F
100	1	14.5	-51.623	-60.921	2350	23.5	340.75	38.817	101.871
150	1.5	21.75	-43.327	-45.989	2400	24	348	39.68	103.424
200	2	29	-36.992	-34.586	2450	24.5	355.25	40.531	104.956
250	2.5	36.25	-31.795	-25.231	2500	25	362.5	41.368	106.462
300	3	43.5	-27.351	-17.232	2550	25.5	369.75	42.192	107.946
350	3.5	50.75	-23.448	-10.206	2600	26	377	43.004	109.407
400	4	58	-19.953	-3.915	2650	26.5	384.25	43.804	110.847
450	4.5	65.25	-16.779	1.798	2700	27	391.5	44.592	112.266
500	5	72.5	-13.863	7.047	2750	27.5	398.75	45.37	113.666
550	5.5	79.75	-11.162	11.908	2800	28	406	46.136	115.045
600	6	87	-8.643	16.444	2850	28.5	413.25	46.892	116.406
650	6.5	94.25	-6.277	20.701	2900	29	420.5	47.638	117.748
700	7	101.5	-4.046	24.716	2950	29.5	427.75	48.374	119.073
750	7.5	108.75	-1.933	28.521	3000	30	435	49.101	120.382
800	8	116	0.076	32.137	3050	30.5	442.25	49.818	121.672
850	8.5	123.25	1.993	35.587	3100	31	449.5	50.525	122.945
900	9	130.5	3.826	38.888	3150	31.5	456.75	51.224	124.203
950	9.5	137.75	5.584	42.052	3200	32	464	51.914	125.445
1000	10	145	7.274	45.093	3250	32.5	471.25	52.596	126.673
1050	10.5	152.25	8.901	48.022	3300	33	478.5	53.27	127.886
1100	11	159.5	10.471	50.848	3350	33.5	485.75	53.935	129.083
1150	11.5	166.75	11.988	53.578	3400	34	493	54.593	130.267
1200	12	174	13.457	56.223	3450	34.5	500.25	55.243	131.437
1250	12.5	181.25	14.879	58.782	3500	35	507.5	55.885	132.593
1300	13	188.5	16.26	61.268	3550	35.5	514.75	56.52	133.736
1350	13.5	195.75	17.602	63.684	3600	36	522	57.148	134.866
1400	14	203	18.906	66.031	3650	36.5	529.25	57.769	135.984
1450	14.5	210.25	20.176	68.317	3700	37	536.5	58.383	137.089
1500	15	217.5	21.414	70.545	3750	37.5	543.75	58.99	138.182
1550	15.5	224.75	22.621	72.718	3800	38	551	59.591	139.264
1600	16	232	23.799	74.838	3850	38.5	558.25	60.185	140.333
1650	16.5	239.25	24.949	76.908	3900	39	565.5	60.773	141.391
1700	17	246.5	26.074	78.933	3950	39.5	572.75	61.355	142.439
1750	17.5	253.75	27.174	80.913	4000	40	580	61.93	143.474
1800	18	261	28.251	82.852	4050	40.5	587.25	62.499	144.498
1850	18.5	268.25	29.305	84.749	4100	41	594.5	63.063	145.513
1900	19	275.5	30.338	86.608	4150	41.5	601.75	63.62	146.516
1950	19.5	282.75	31.351	88.432	4200	42	609	64.172	147.510
2000	20	290	32.344	90.219	4250	42.5	616.25	64.719	148.494
2050	20.5	297.25	33.319	91.974	4300	43	623.5	65.259	149.466
2100	21	304.5	34.276	93.697	4350	43.5	630.75	65.795	150.431
2150	21.5	311.75	35.215	95.387	4400	44	638	66.324	151.383
2200	22	319	36.139	97.050	4450	44.5	645.25	66.849	152.328
2250	22.5	326.25	37.047	98.685	4500	45	652.5	67.368	153.262
2300	23	333.5	37.939	100.290					



## System Pressure Table-R32

Pressure			Temperature		Pressure			Temperature	
Kpa	bar	PSI	°C	°F	Kpa	bar	PSI	°C	°F
100	1	14.5	-51.909	-61.436	1850	18.5	268.25	28.425	83.165
150	1.5	21.75	-43.635	-46.543	1900	19	275.5	29.447	85.005
200	2	29	-37.323	-35.181	1950	19.5	282.75	30.448	86.806
250	2.5	36.25	-32.15	-25.87	2000	20	290	31.431	88.576
300	3	43.5	-27.731	-17.916	2050	20.5	297.25	32.395	90.311
350	3.5	50.75	-23.85	-10.93	2100	21	304.5	33.341	92.014
400	4	58	-20.378	-4.680	2150	21.5	311.75	34.271	93.688
450	4.5	65.25	-17.225	0.995	2200	22	319	35.184	95.331
500	5	72.5	-14.331	6.204	2250	22.5	326.25	36.082	96.948
550	5.5	79.75	-11.65	11.03	2300	23	333.5	36.965	98.537
600	6	87	-9.150	15.529	2350	23.5	340.75	37.834	100.101
650	6.5	94.25	-6.805	19.752	2400	24	348	38.688	101.638
700	7	101.5	-4.593	23.734	2450	24.5	355.25	39.529	103.152
750	7.5	108.75	-2.498	27.505	2500	25	362.5	40.358	104.644
800	8	116	-0.506	31.089	2550	25.5	369.75	41.173	106.111
850	8.5	123.25	1.393	34.507	2600	26	377	41.977	107.559
900	9	130.5	3.209	37.777	2650	26.5	384.25	42.769	108.984
950	9.5	137.75	4.951	40.911	2700	27	391.5	43.55	110.39
1000	10	145	6.624	43.923	2750	27.5	398.75	44.32	111.776
1050	10.5	152.25	8.235	46.823	2800	28	406	45.079	113.142
1100	11	159.5	9.790	49.621	2850	28.5	413.25	45.828	114.490
1150	11.5	166.75	11.291	52.324	2900	29	420.5	46.567	115.821
1200	12	174	12.745	54.941	2950	29.5	427.75	47.296	117.133
1250	12.5	181.25	14.153	57.475	3000	30	435	48.015	118.427
1300	13	188.5	15.52	59.936	3050	30.5	442.25	48.726	119.707
1350	13.5	195.75	16.847	62.325	3100	31	449.5	49.428	120.970
1400	14	203	18.138	64.648	3150	31.5	456.75	50.121	122.218
1450	14.5	210.25	19.395	66.911	3200	32	464	50.806	123.451
1500	15	217.5	20.619	69.114	3250	32.5	471.25	51.482	124.668
1550	15.5	224.75	21.813	71.263	3300	33	478.5	52.15	125.87
1600	16	232	22.978	73.360	3350	33.5	485.75	52.811	127.060
1650	16.5	239.25	24.116	75.409	3400	34	493	53.464	128.235
1700	17	246.5	25.229	77.412	3450	34.5	500.25	54.11	129.398
1750	17.5	253.75	26.317	79.371	3500	35	507.5	54.748	130.546
1800	18	261	27.382	81.288					